

Overview

Andreas Mau

Knock Out

Andreas Mau			
Knock Out			
Sheet Number: 1 of 30	Date: 10/03/2015	Drawing Number: RQA3KO0001	Material:
Sheet Size: A3	Drawn By: R. Quinton	Drawing Units: Millimeters	

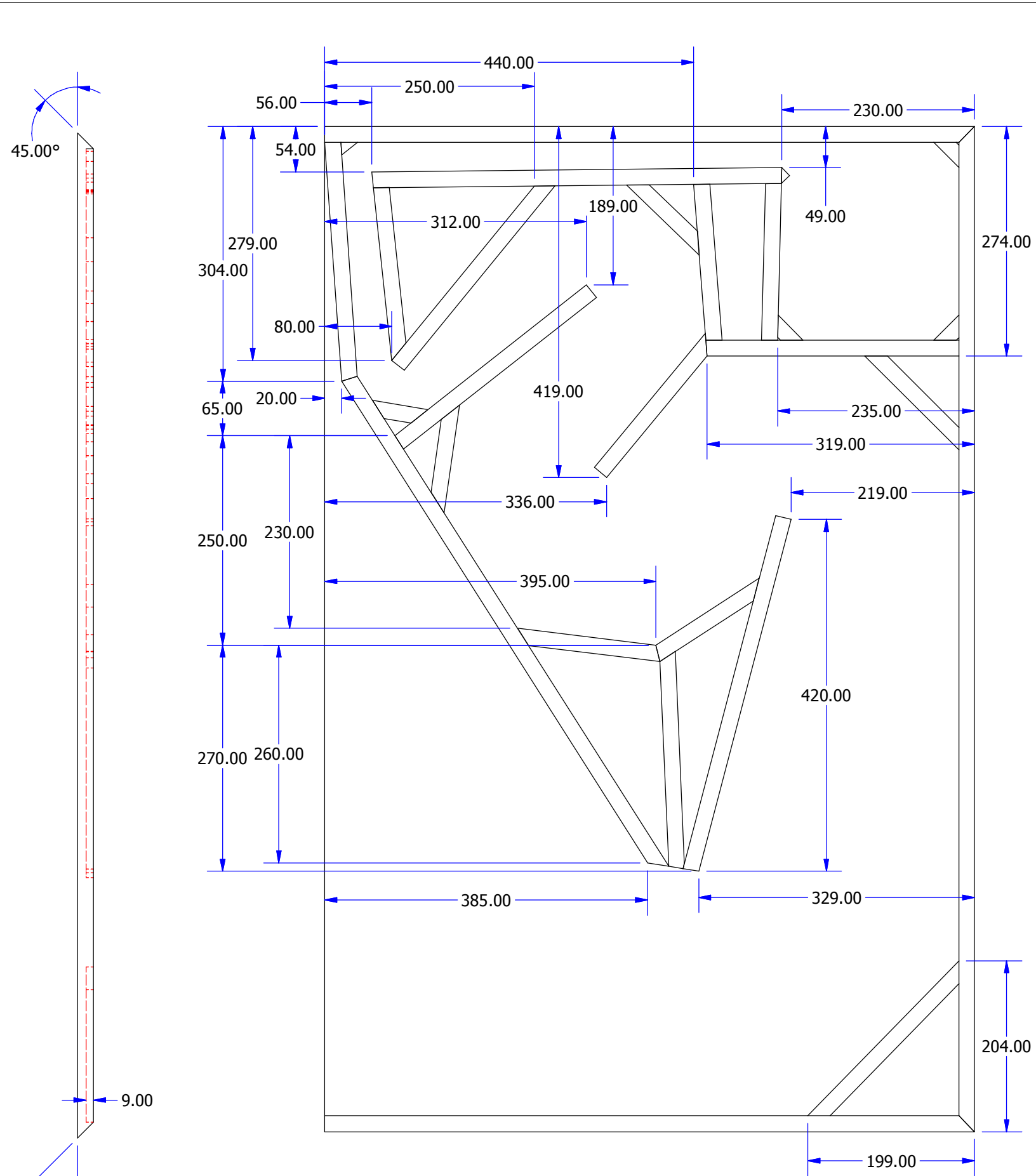

Rear Panel

All rebates are 19.00mm wide x 9.00mm deep.
A mirror image of this panel is required for the opposite cabinet.

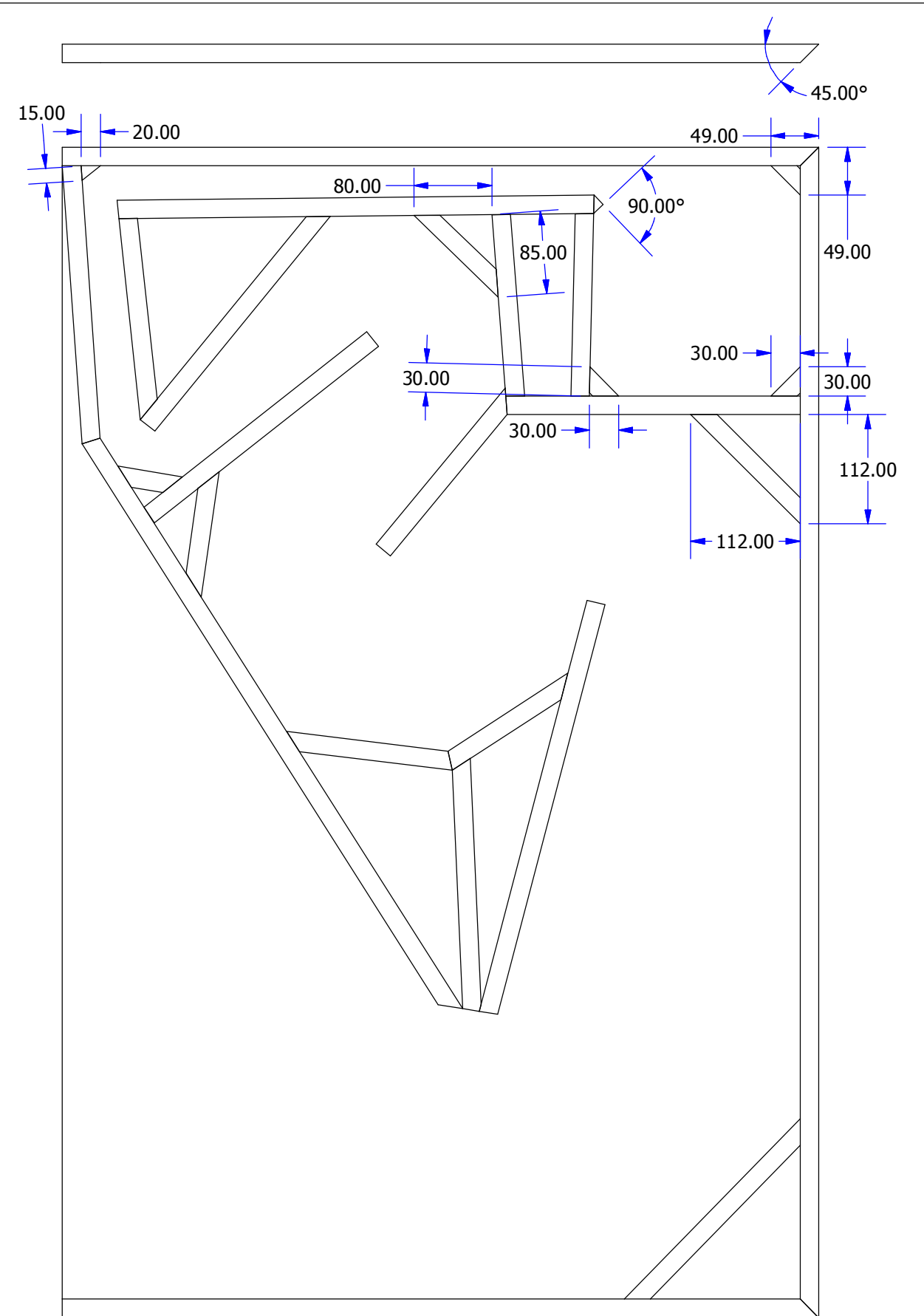

Andreas Mau
Knock Out

Sheet Number: 2 of 30	Date: 10/03/2015	Drawing Number: RQA3KO0001	Material: 19mm MDF
Sheet Size: A3	Drawn By: R. Quinton	Drawing Units: Millimeters	

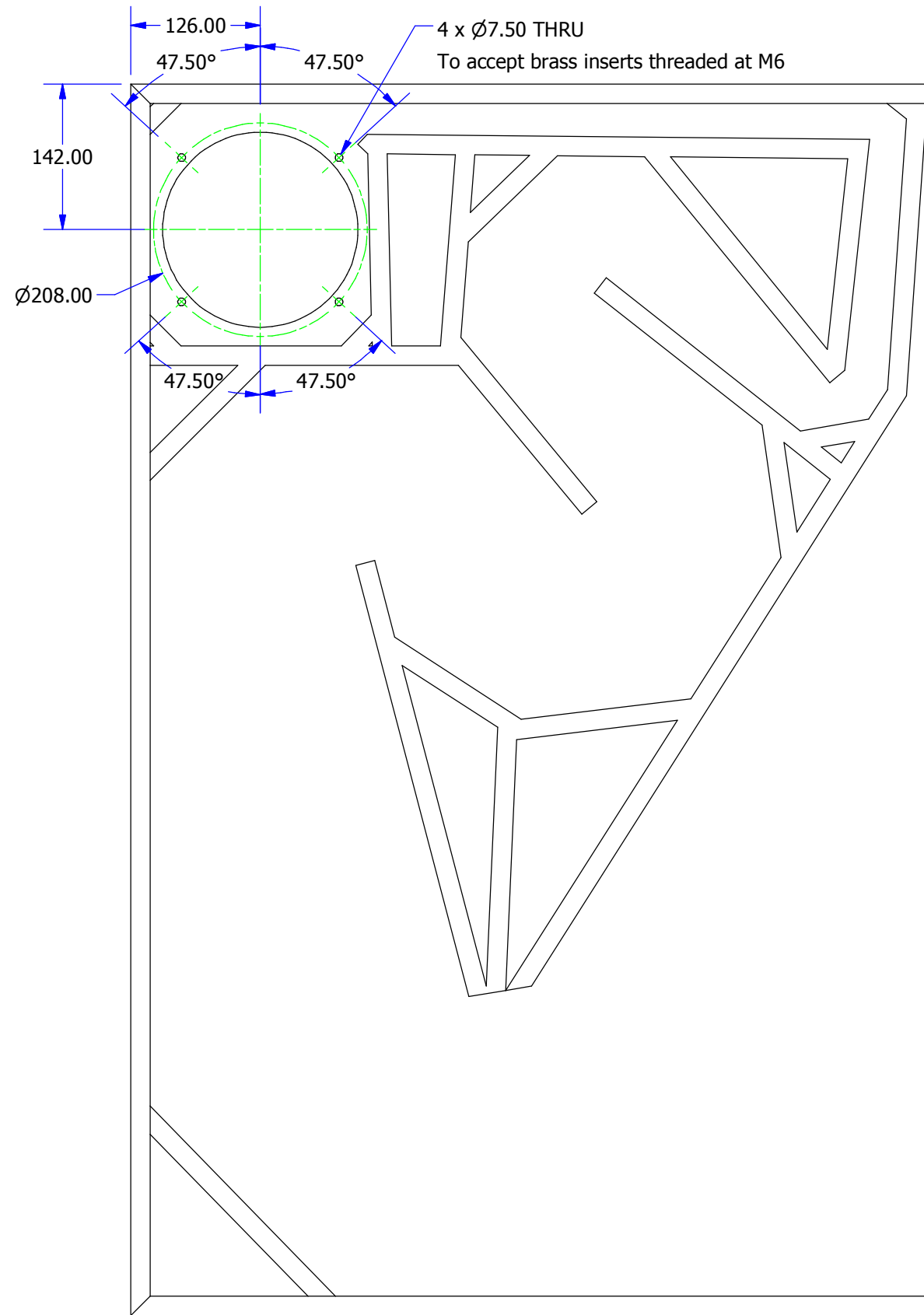

Front Panel

For details of rebates see Rear Panel.
A mirror image of this panel is required for the opposite cabinet.

Andreas Mau			
Knock Out			
Sheet Number: 3 of 30	Date: 10/03/2015	Drawing Number: RQA3KO0001	Material: 19mm MDF
Sheet Size: A3	Drawn By: R. Quinton	Drawing Units: Millimeters	

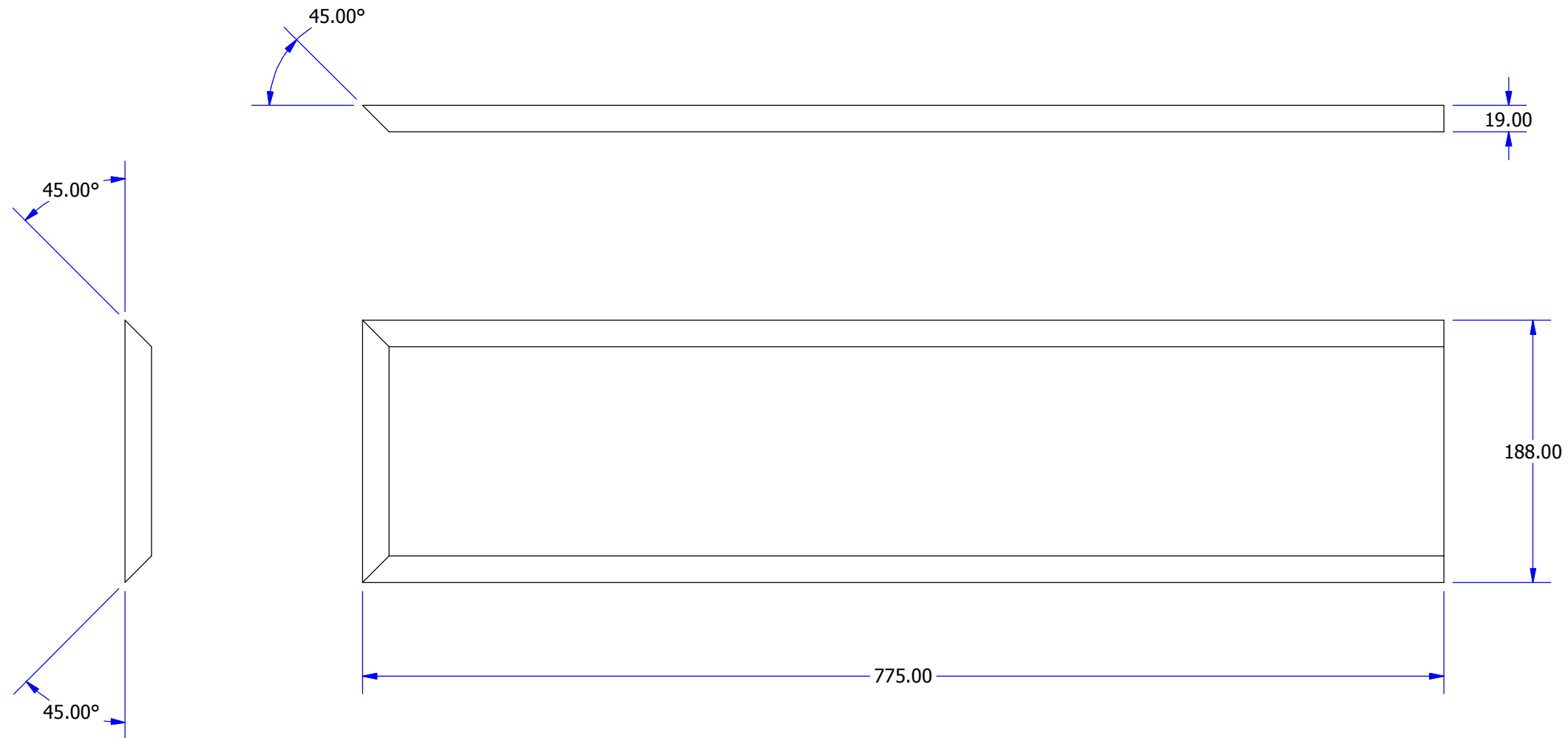

Two of these panels are required

Top & Bottom Panels

Andreas Mau			
Knock Out			
Sheet Number: 4 of 30	Date: 10/03/2015	Drawing Number: RQA3KO0001	Material: 19mm MDF
Sheet Size: A3	Drawn By: R. Quinton	Drawing Units: Millimeters	

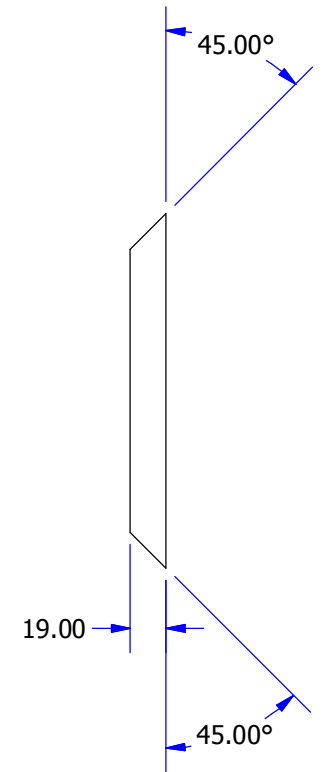
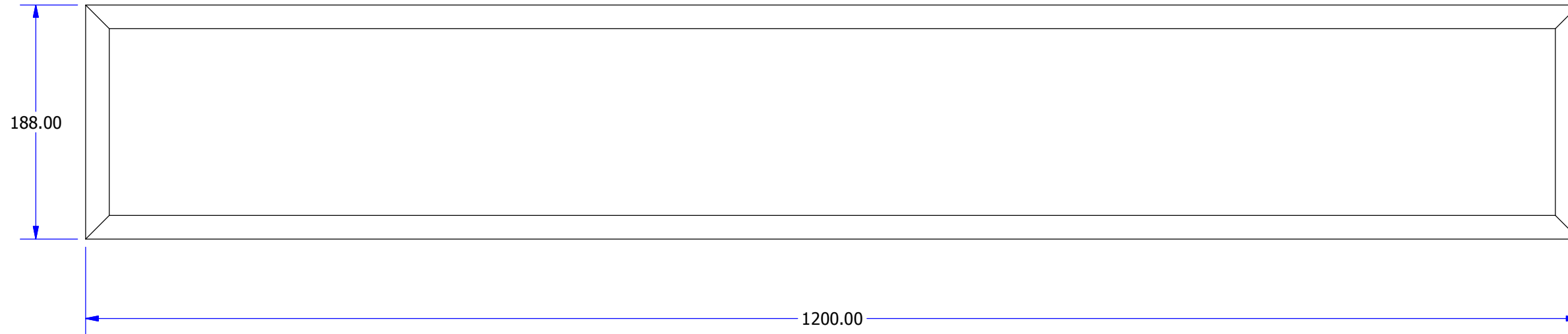
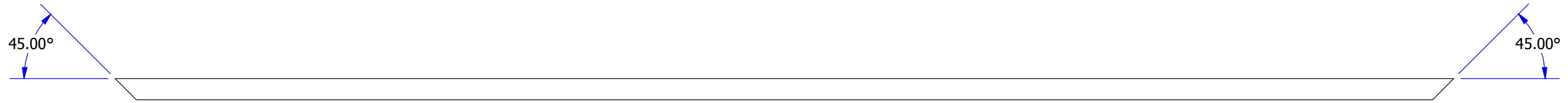

Side Panel

Andreas Mau

Knock Out

Sheet Number: 5 of 30				Date: 10/03/2015		Drawing Number: RQA3KO0001		Material: 19mm MDF	
Sheet Size: A3				Drawn By: R. Quinton		Drawing Units: Millimeters			

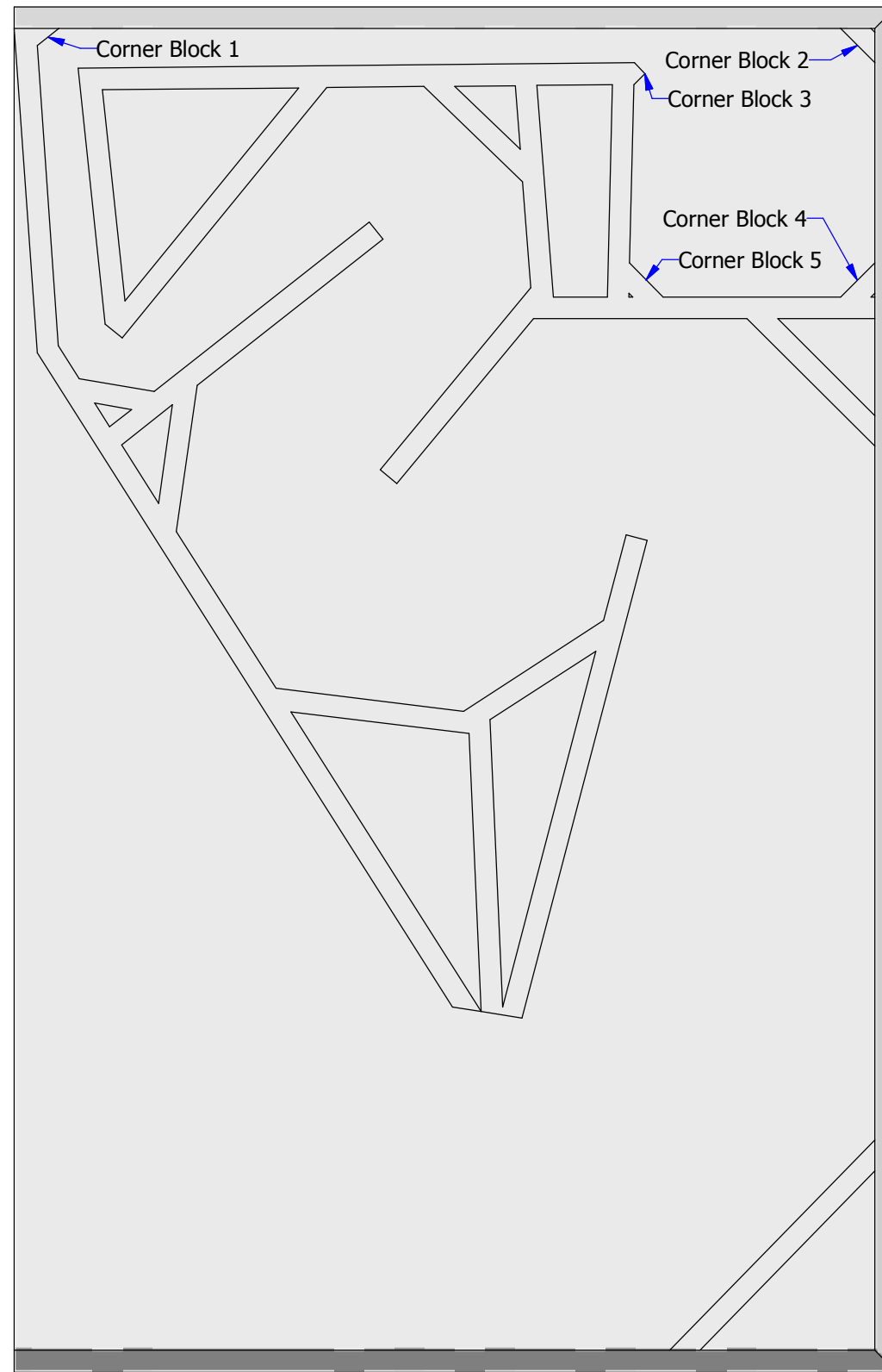
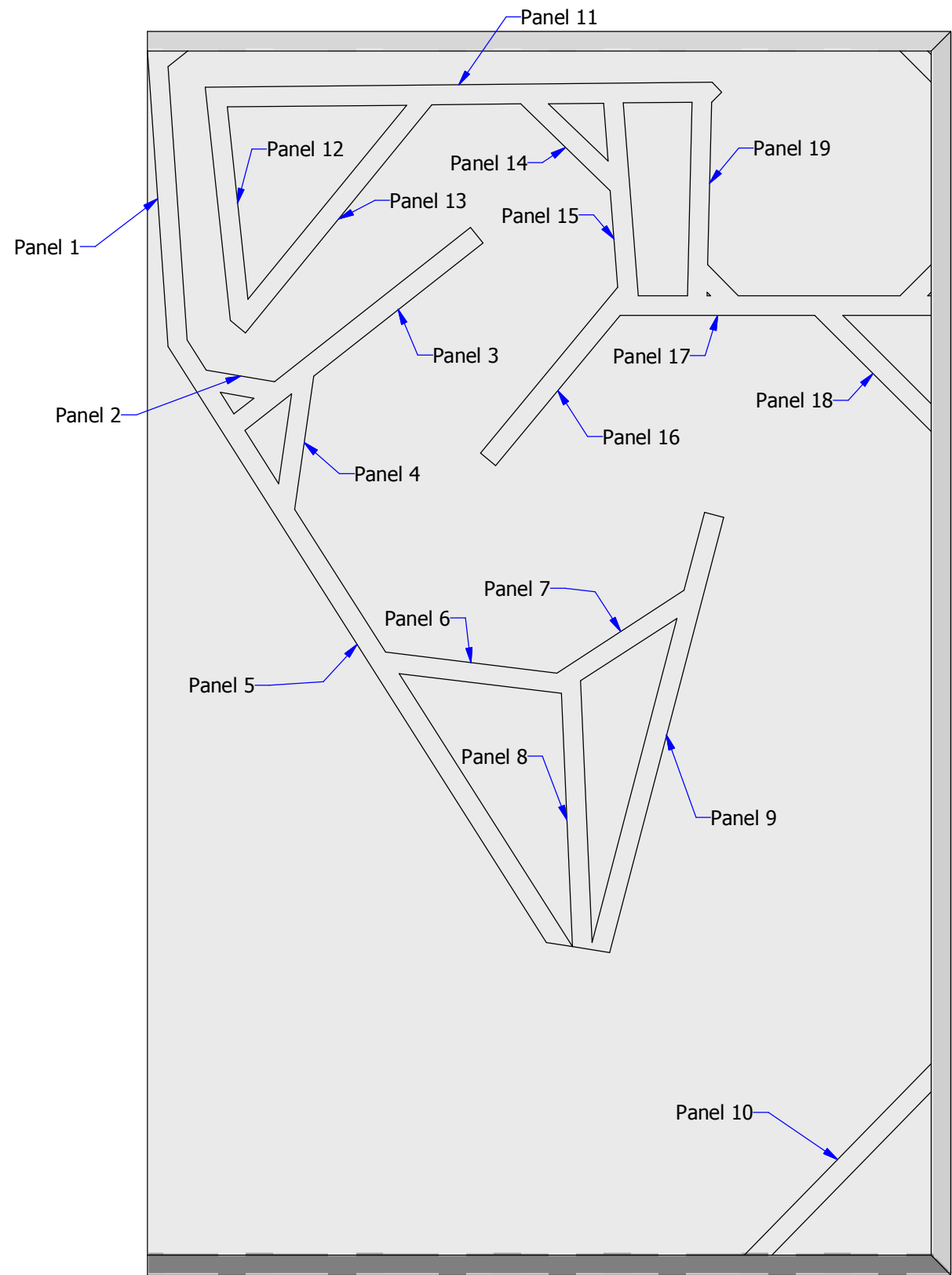

Interior Panels Reference

Andreas Mau			
Knock Out			
Sheet Number: 6 of 30	Date: 10/03/2015	Drawing Number: RQA3KO0001	Material:
Sheet Size: A3	Drawn By: R. Quinton	Drawing Units: Millimeters	

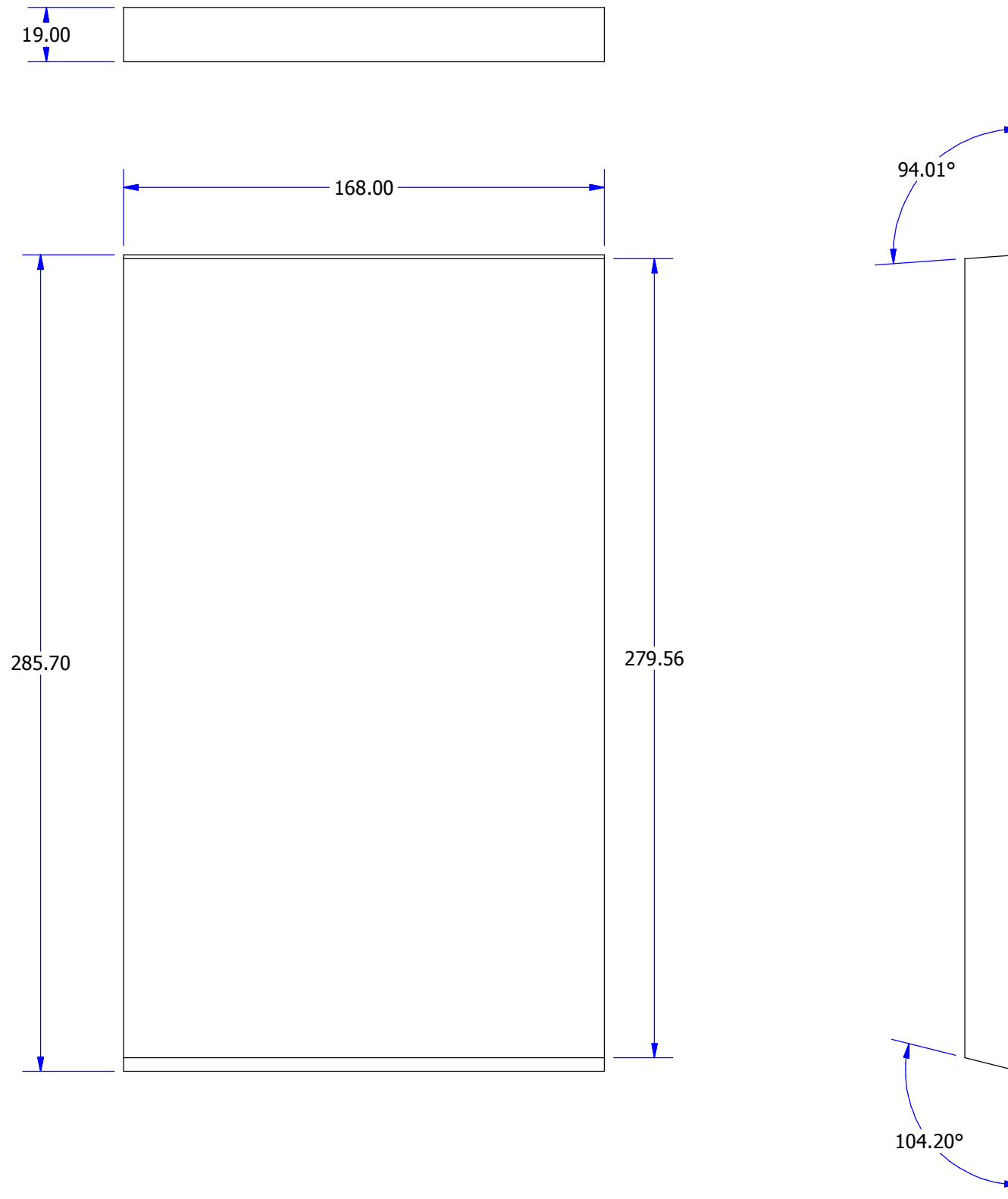

Panel 1

Andreas Mau			
Knock Out			
Sheet Number: 7 of 30	Date: 10/03/2015	Drawing Number: RQA3KO0001	Material: 19mm MDF
Sheet Size: A3	Drawn By: R. Quinton	Drawing Units: Millimeters	

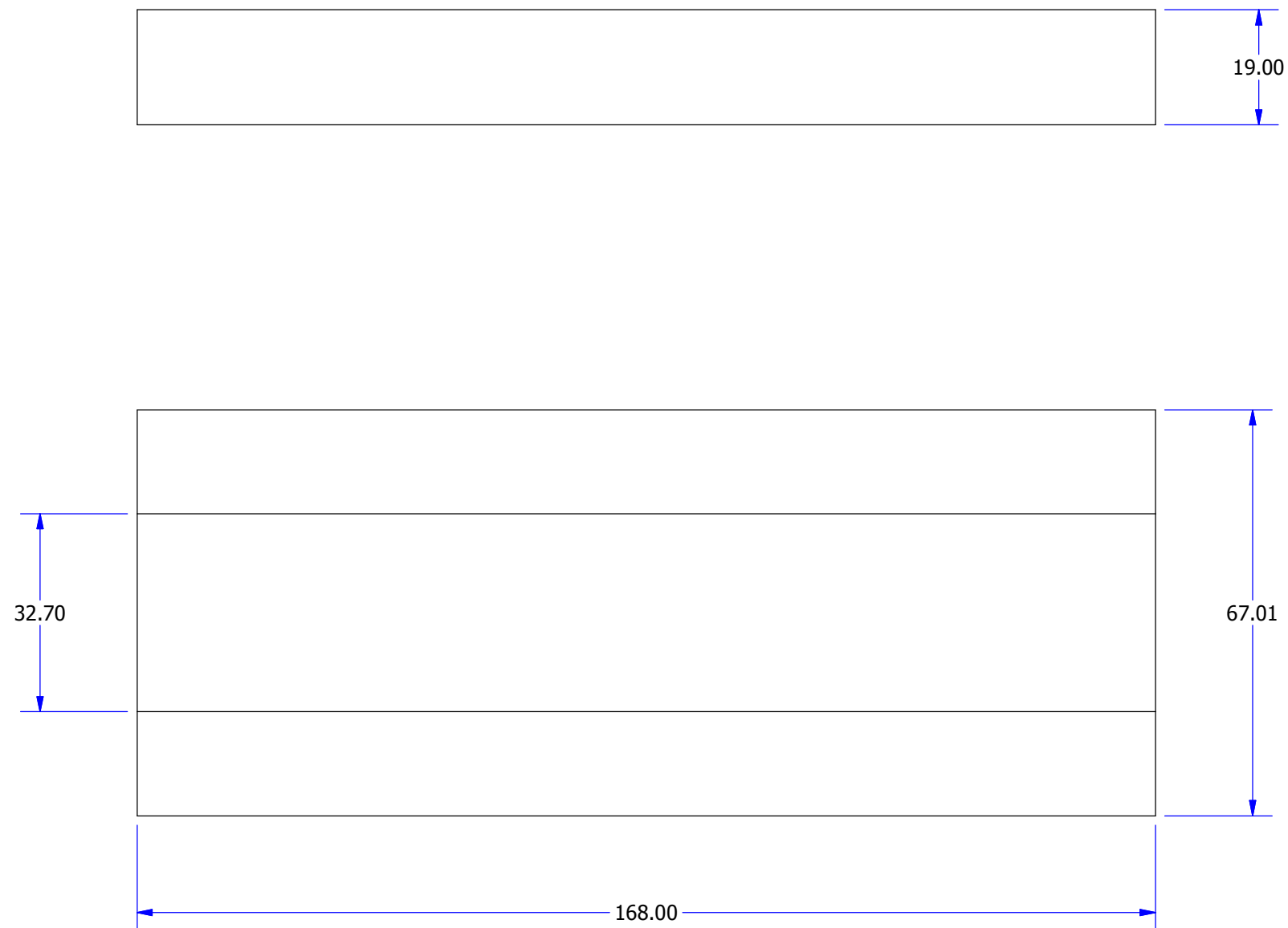

19.00

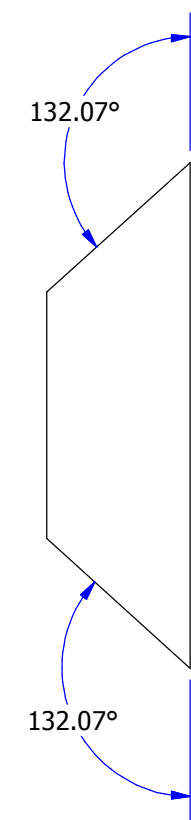

Panel 2

Andreas Mau			
Knock Out			
Sheet Number: 8 of 30	Date: 10/03/2015	Drawing Number: RQA3KO0001	Material: 19mm MDF
Sheet Size: A3	Drawn By: R. Quinton	Drawing Units: Millimeters	

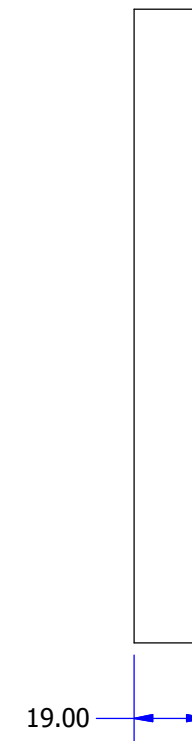
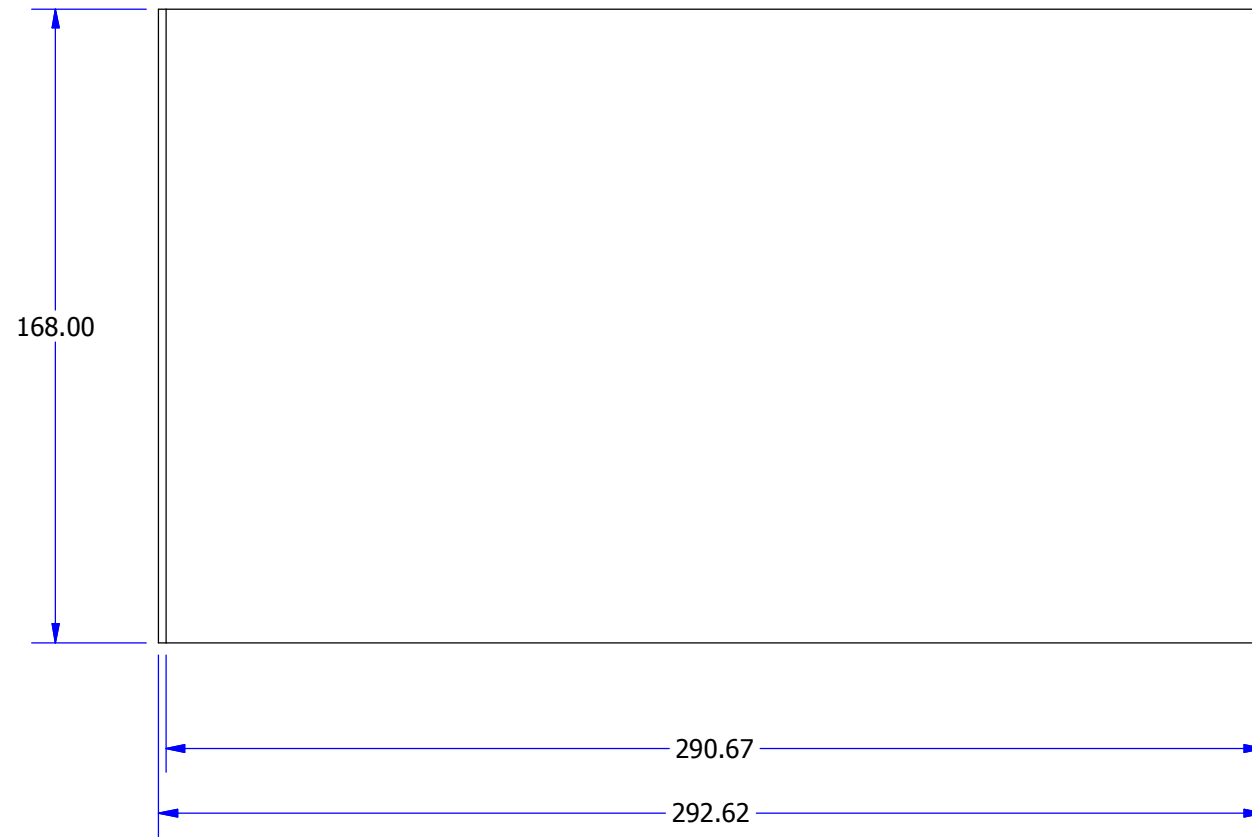
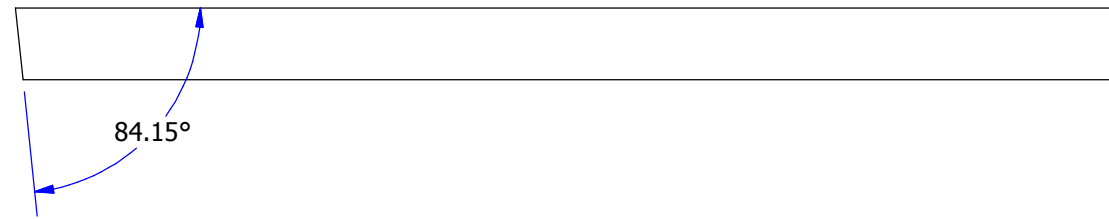

Panel 3

Andreas Mau

Knock Out

Andreas Mau			
Knock Out			
Sheet Number: 9 of 30	Date: 10/03/2015	Drawing Number: RQA3KO0001	Material: 19mm MDF
Sheet Size: A3	Drawn By: R. Quinton	Drawing Units: Millimeters	

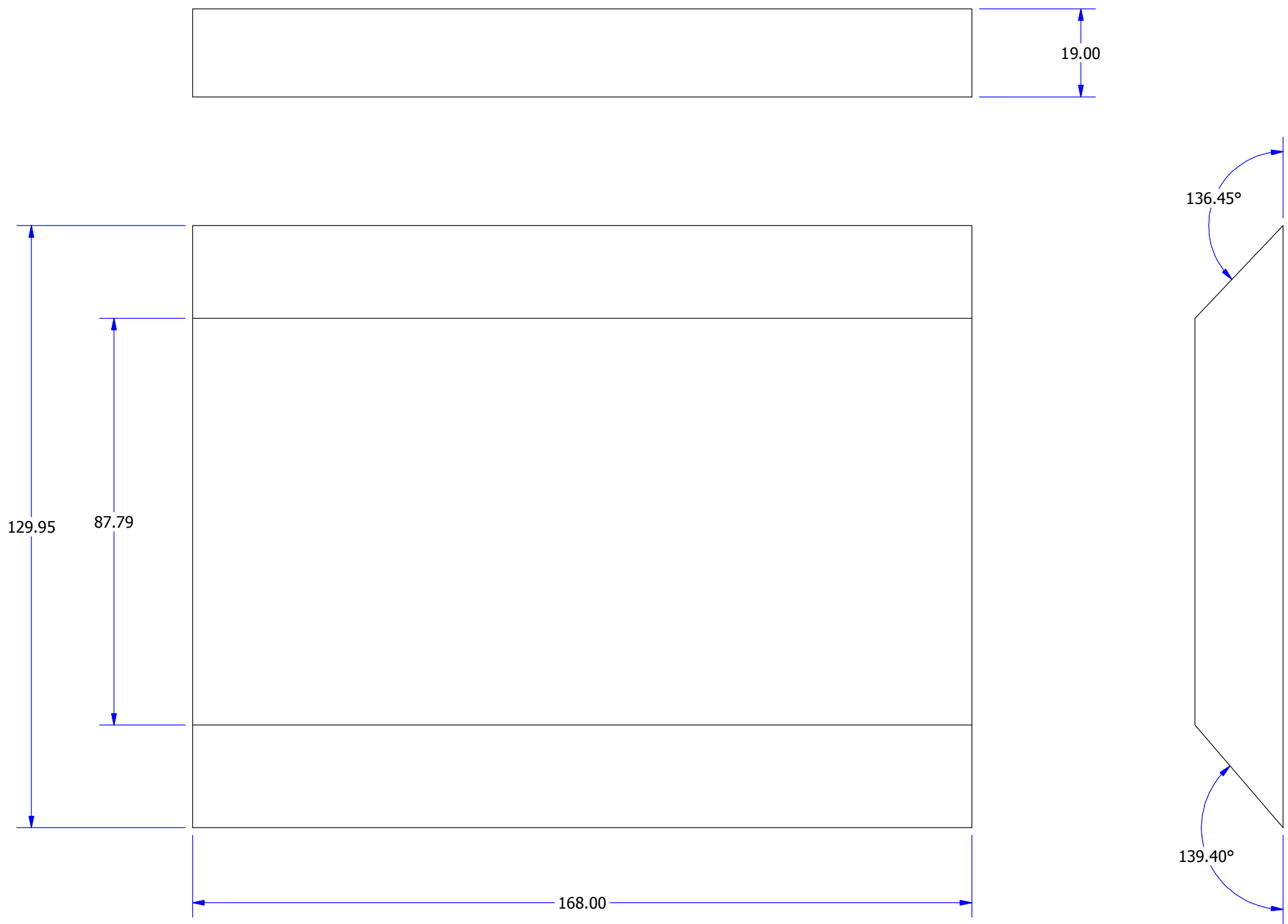

Panel 4

Andreas Mau			
Knock Out			
Sheet Number: 10 of 30	Date: 10/03/2015	Drawing Number: RQA3KO0001	Material: 19mm MDF
Sheet Size: A3	Drawn By: R. Quinton	Drawing Units: Millimeters	

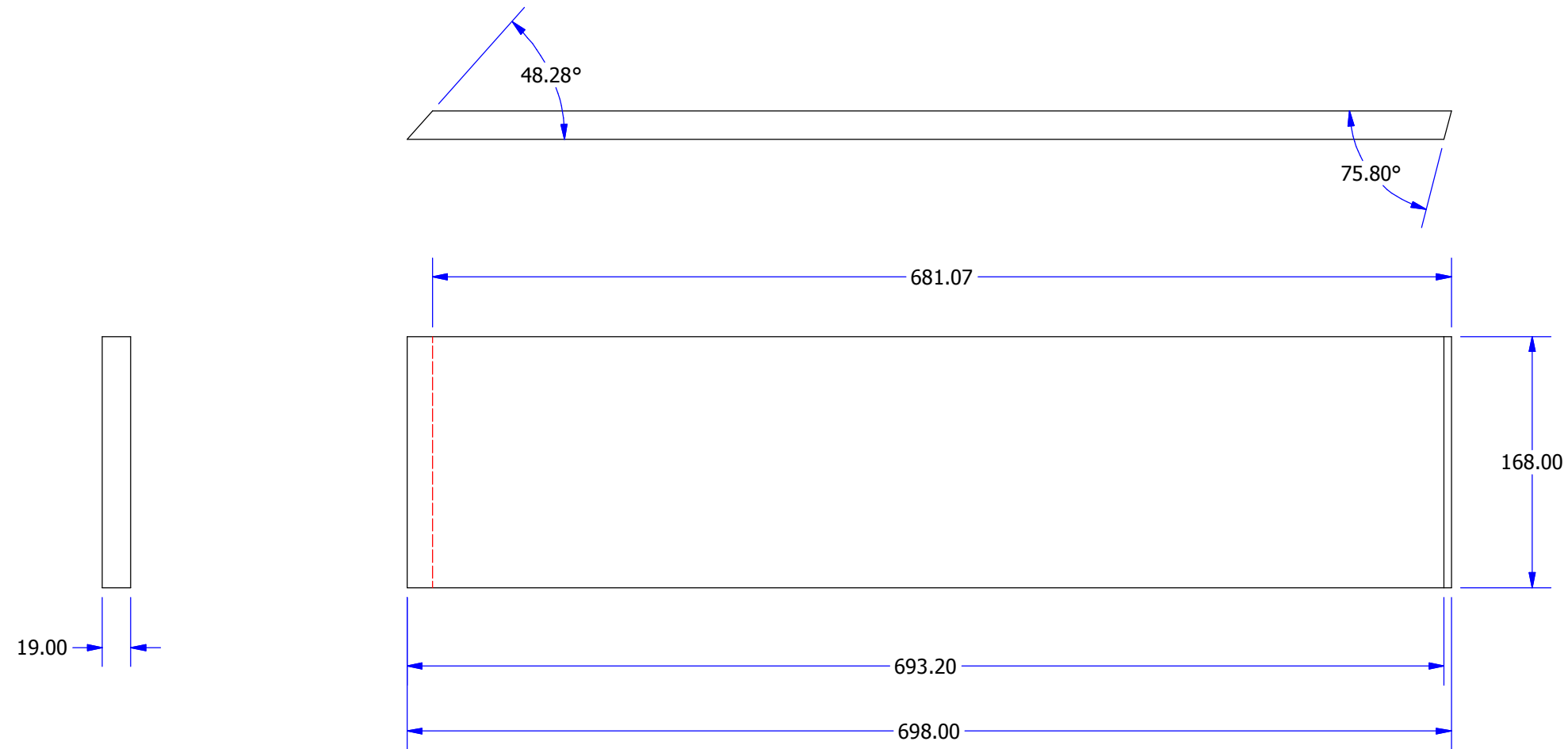

Panel 5

Andreas Mau

Knock Out

Andreas Mau			
Knock Out			
Sheet Number: 11 of 30	Date: 10/03/2015	Drawing Number: RQA3KO0001	Material: 19mm MDF
Sheet Size: A3	Drawn By: R. Quinton	Drawing Units: Millimeters	

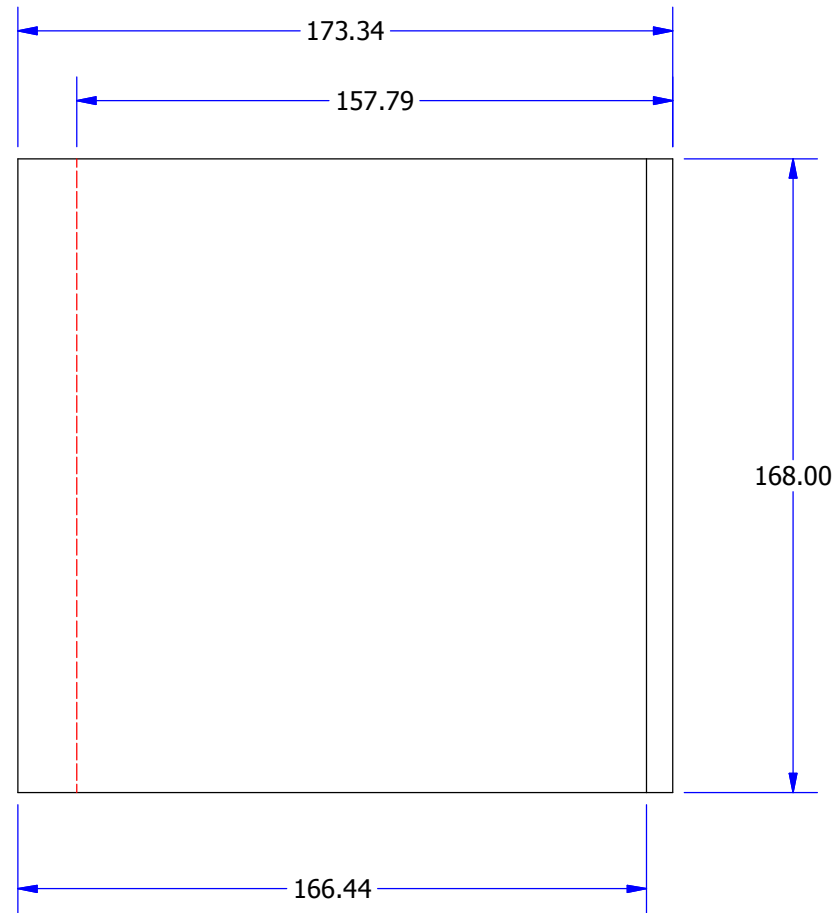
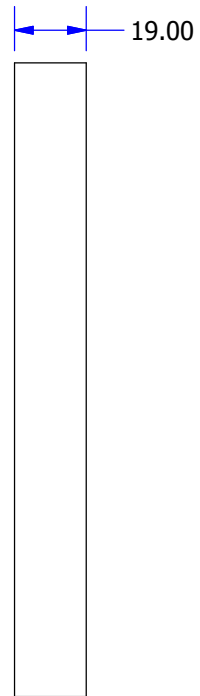

Panel 6

Andreas Mau

Knock Out

Andreas Mau			
Knock Out			
Sheet Number: 12 of 30	Date: 10/03/2015	Drawing Number: RQA3KO0001	Material: 19mm MDF
Sheet Size: A3	Drawn By: R. Quinton	Drawing Units: Millimeters	

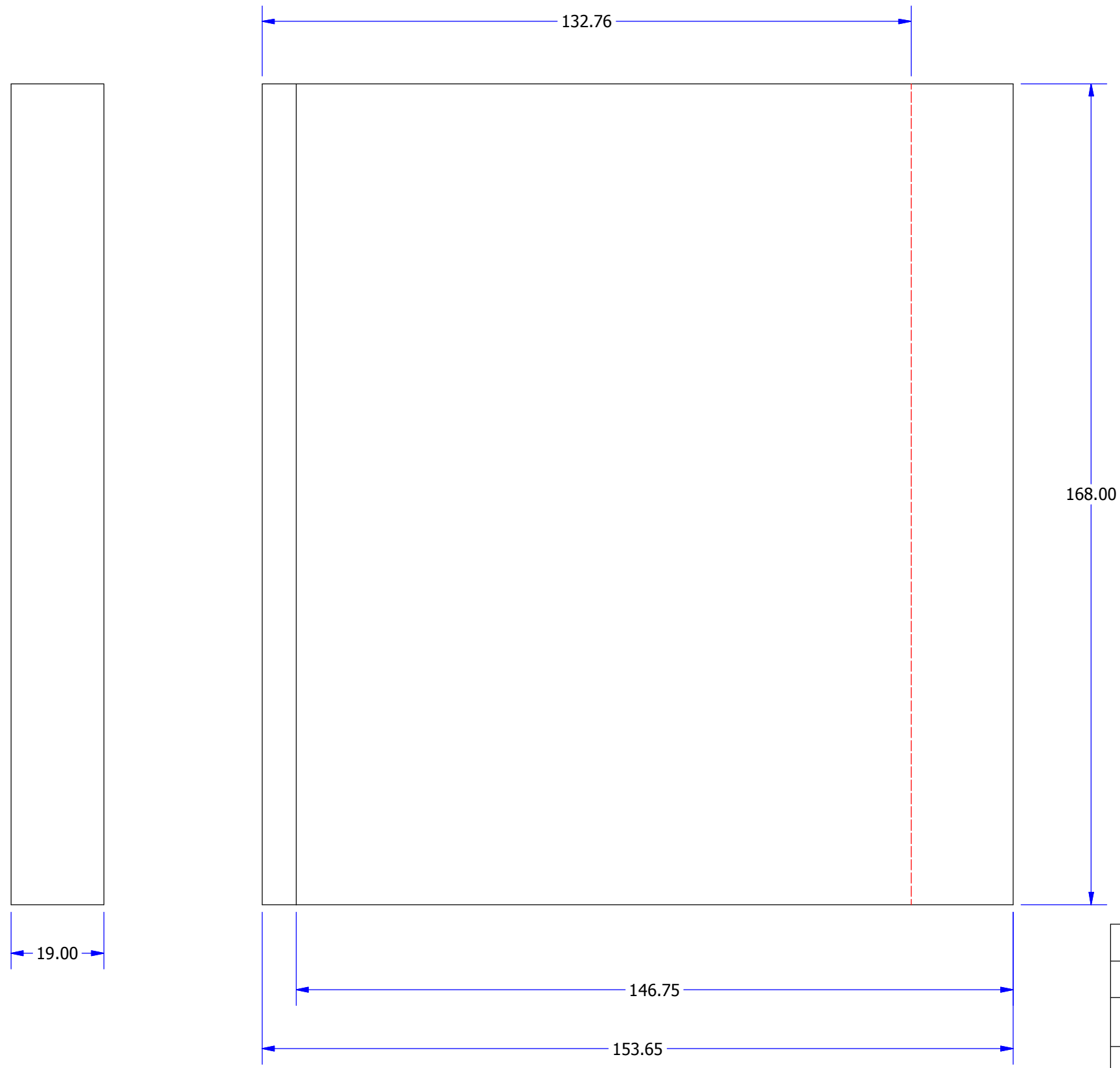

Panel 7

Andreas Mau			
Knock Out			
Sheet Number: 13 of 30	Date: 10/03/2015	Drawing Number: RQA3KO0001	Material: 19mm MDF
Sheet Size: A3	Drawn By: R. Quinton	Drawing Units: Millimeters	

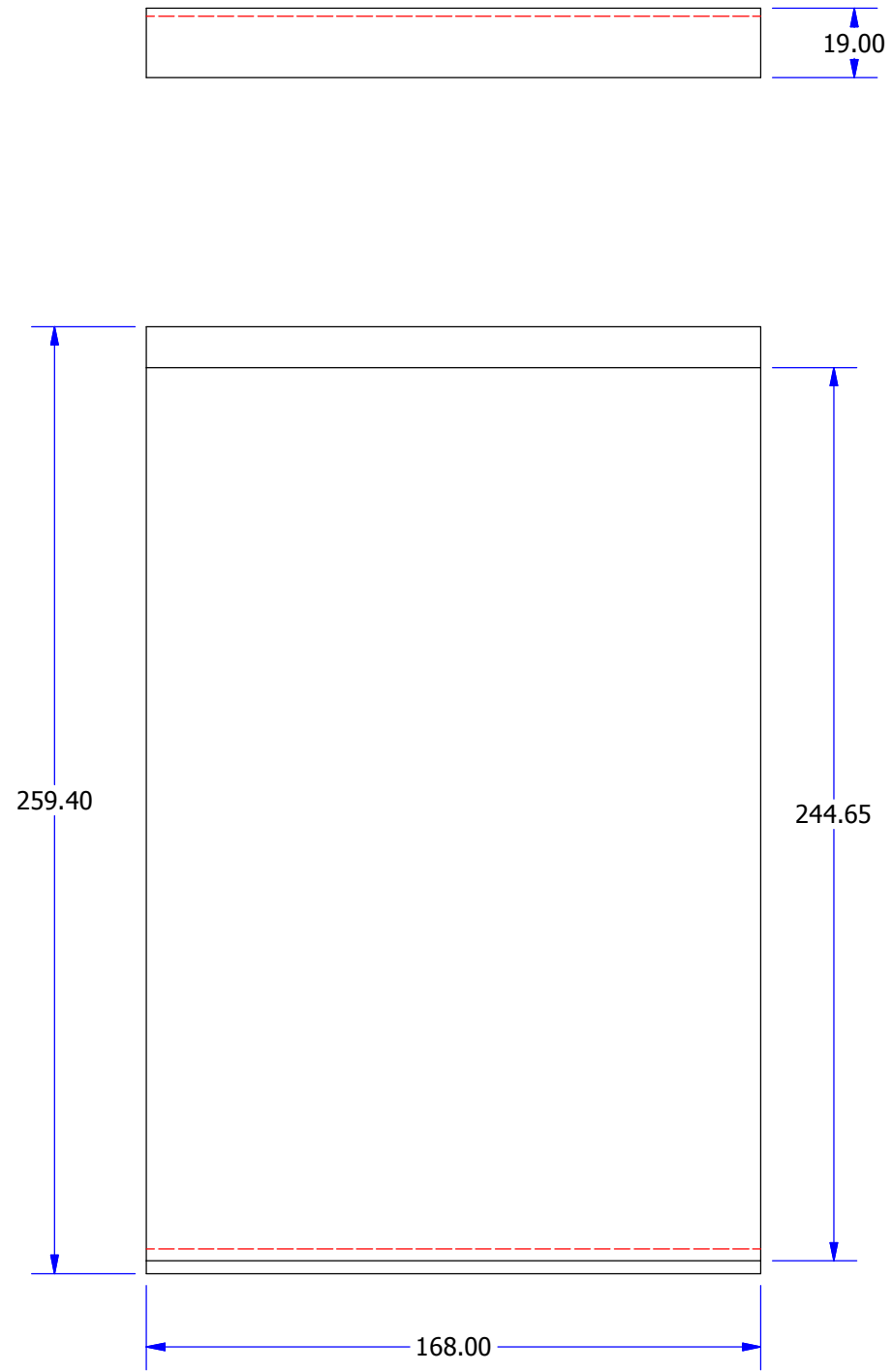
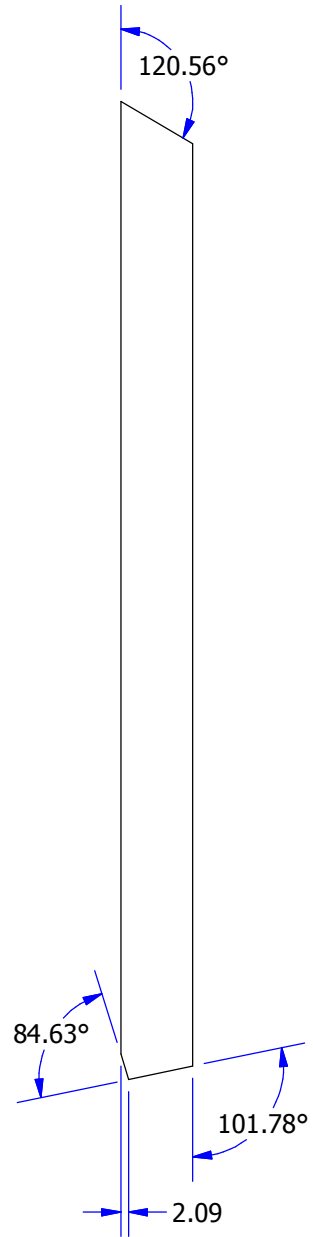

Panel 8

Andreas Mau

Knock Out

Andreas Mau			
Knock Out			
Sheet Number: 14 of 30	Date: 10/03/2015	Drawing Number: RQA3KO0001	Material: 19mm MDF
Sheet Size: A3	Drawn By: R. Quinton	Drawing Units: Millimeters	

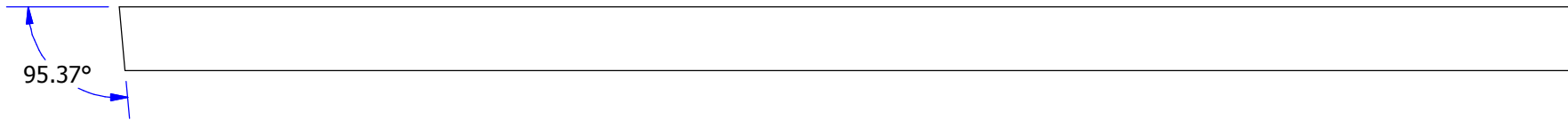

19.00

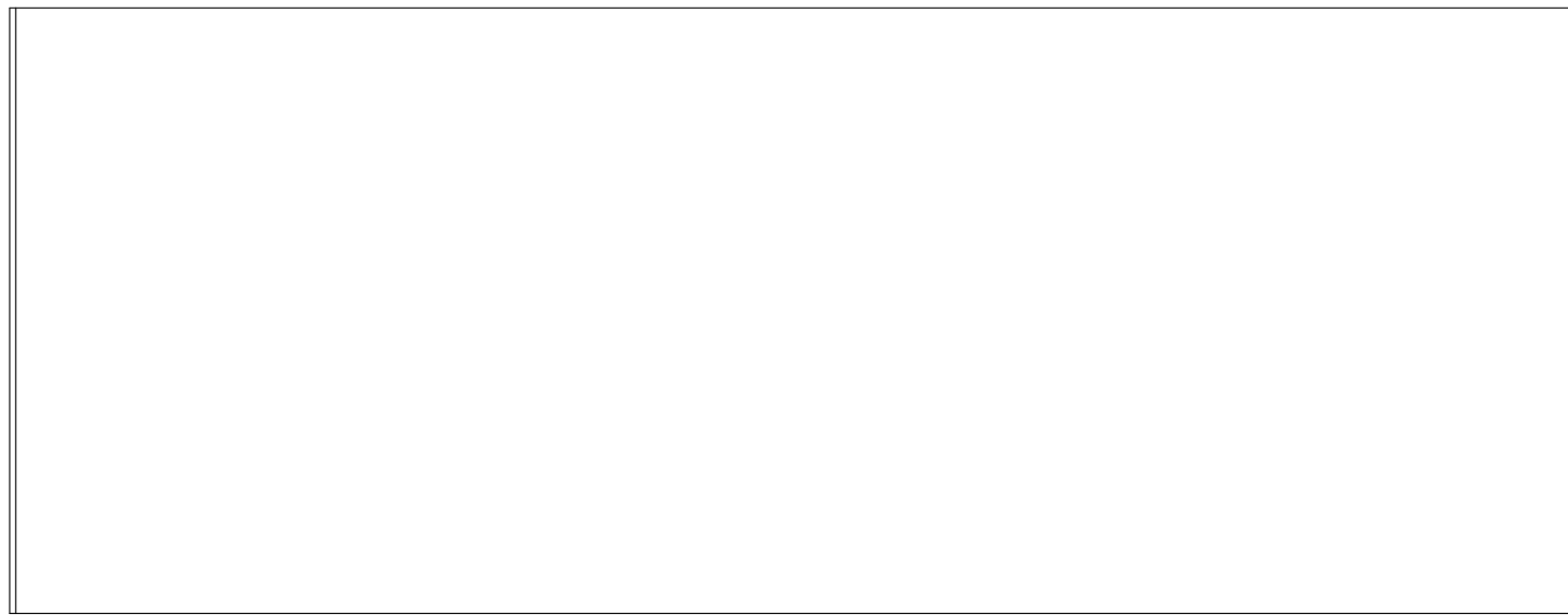

168.00

434.17

435.95

Panel 9

Andreas Mau

Knock Out

Andreas Mau			
Knock Out			
Sheet Number: 15 of 30	Date: 10/03/2015	Drawing Number: RQA3KO0001	Material: 19mm MDF
Sheet Size: A3	Drawn By: R. Quinton	Drawing Units: Millimeters	

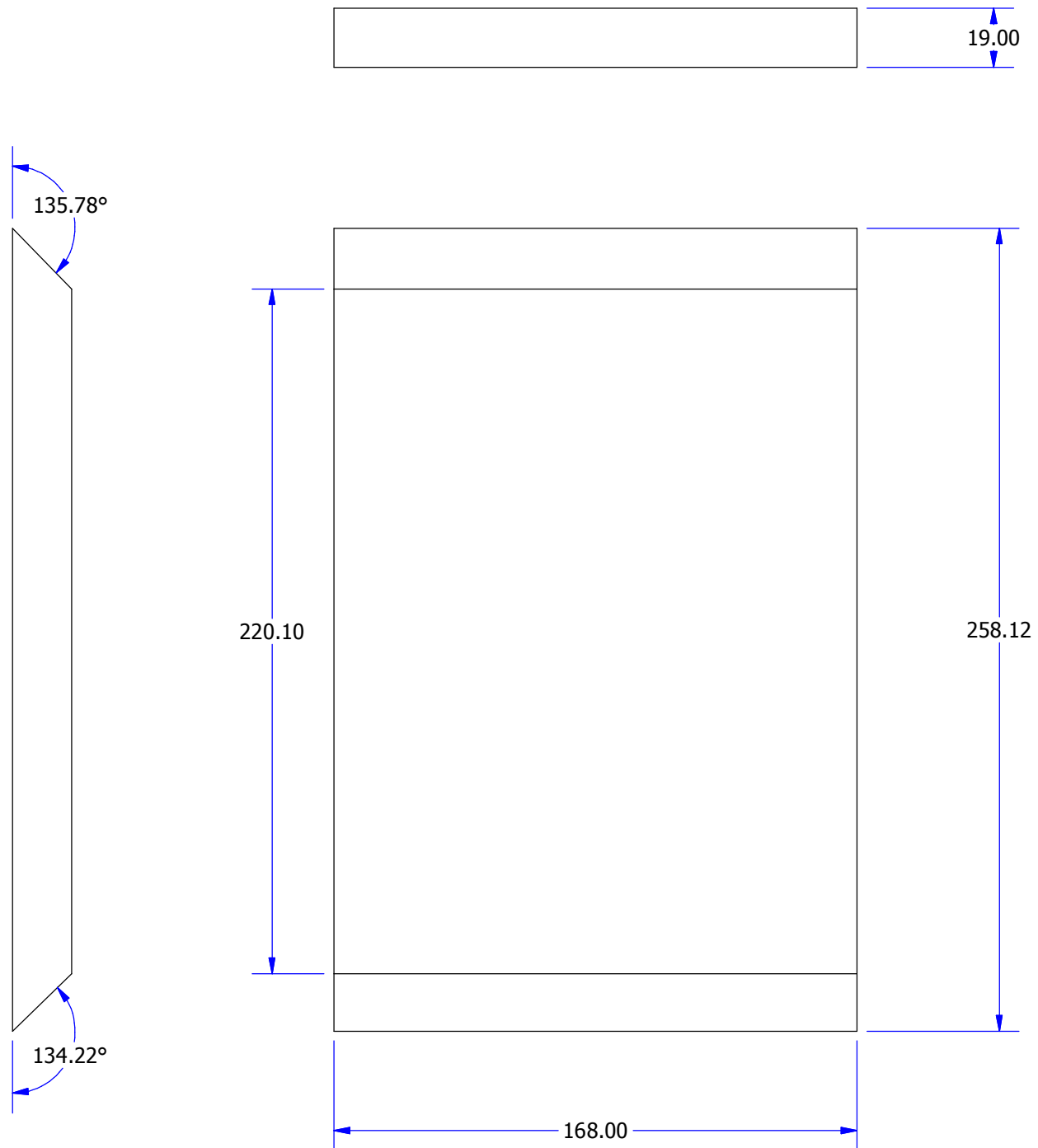

Panel 10

Andreas Mau

Knock Out

Andreas Mau			
Knock Out			
Sheet Number: 16 of 30	Date: 10/03/2015	Drawing Number: RQA3KO0001	Material: 19mm MDF
Sheet Size: A3	Drawn By: R. Quinton	Drawing Units: Millimeters	

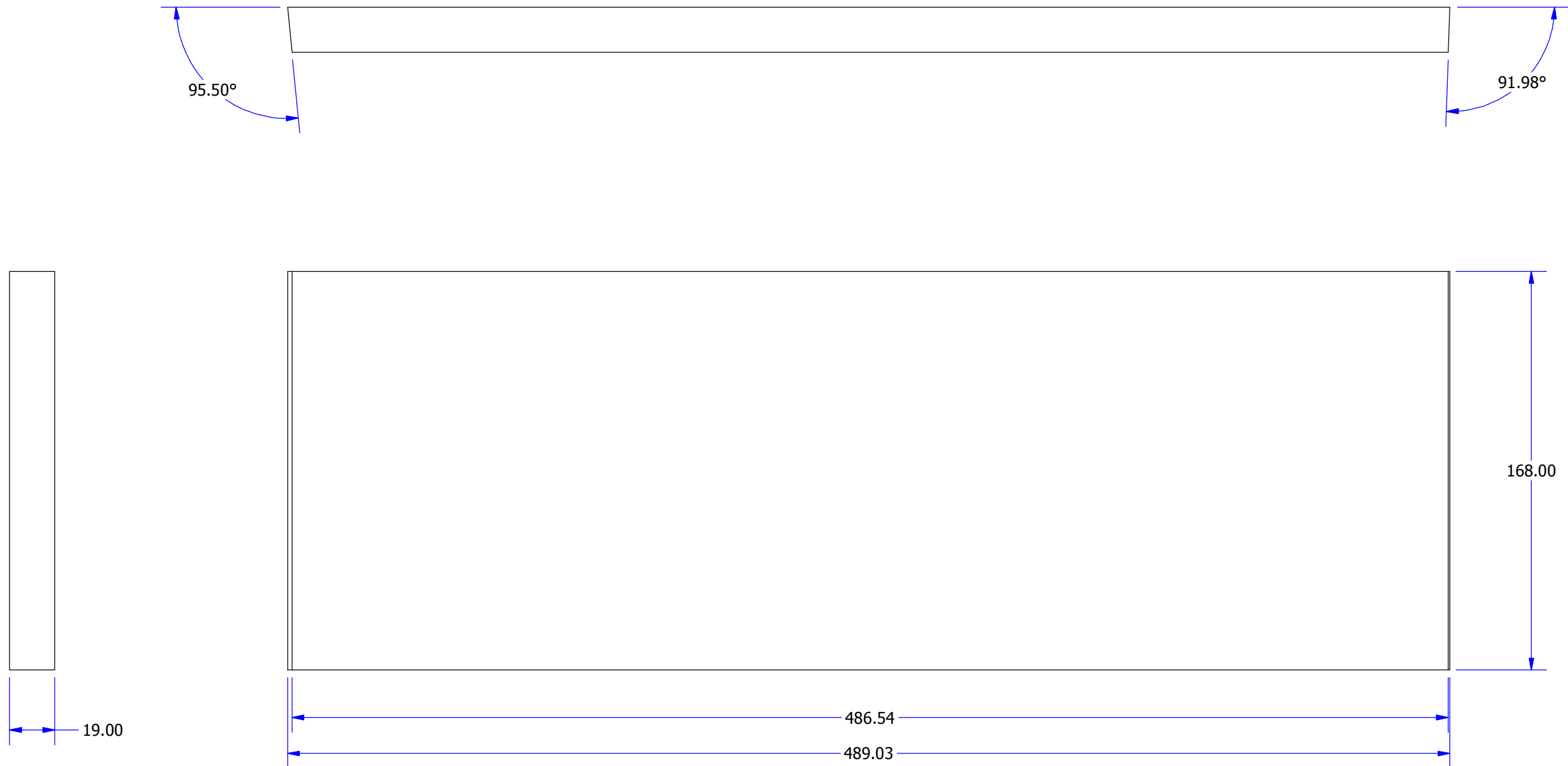

Panel 11

Andreas Mau

Knock Out

Andreas Mau			
Knock Out			
Sheet Number: 17 of 30	Date: 10/03/2015	Drawing Number: RQA3KO0001	Material: 19mm MDF
Sheet Size: A3	Drawn By: R. Quinton	Drawing Units: Millimeters	

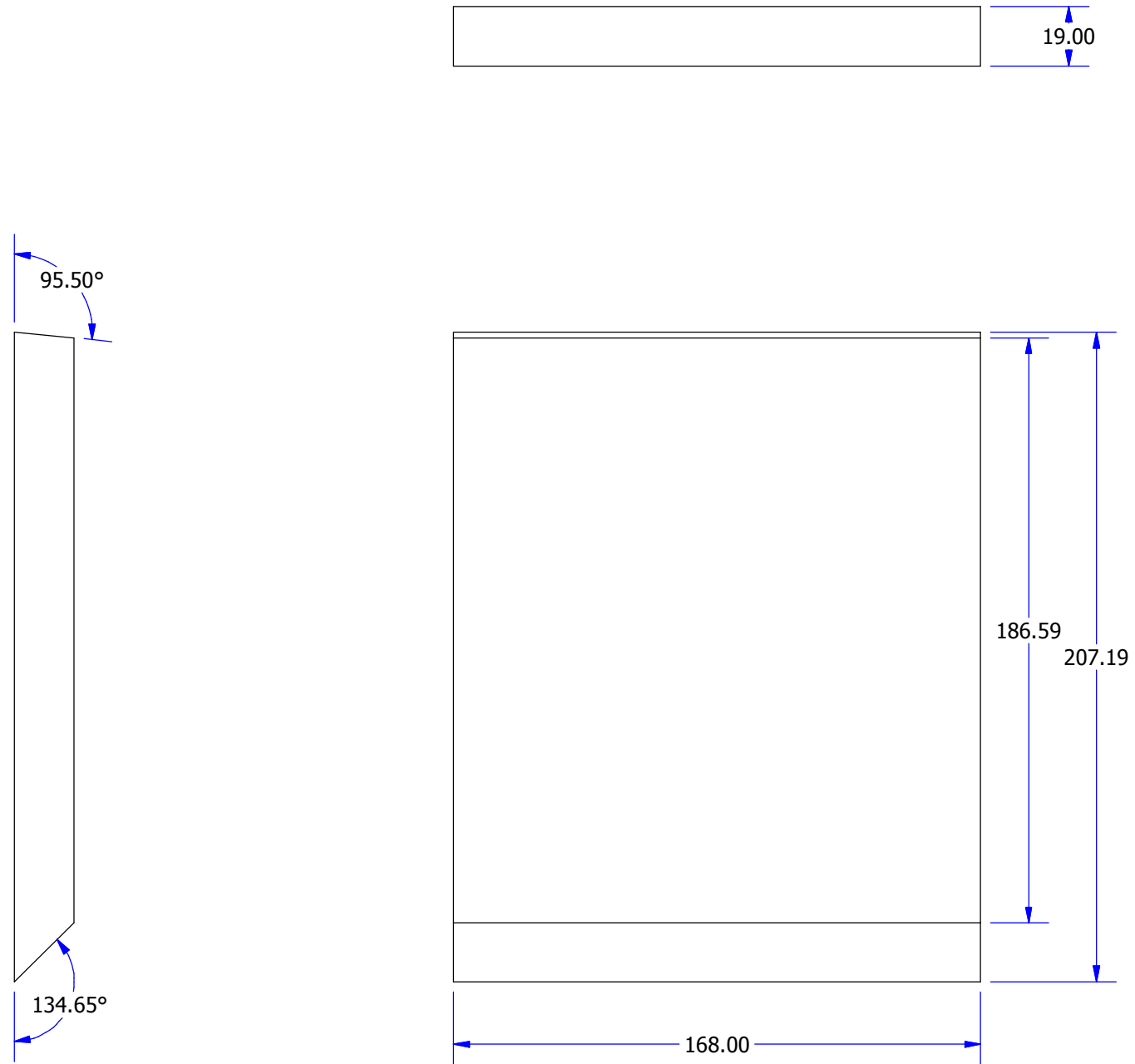

Panel 12

Andreas Mau

Knock Out

Andreas Mau			
Knock Out			
Sheet Number: 18 of 30	Date: 10/03/2015	Drawing Number: RQA3KO0001	Material: 19mm MDF
Sheet Size: A3	Drawn By: R. Quinton	Drawing Units: Millimeters	

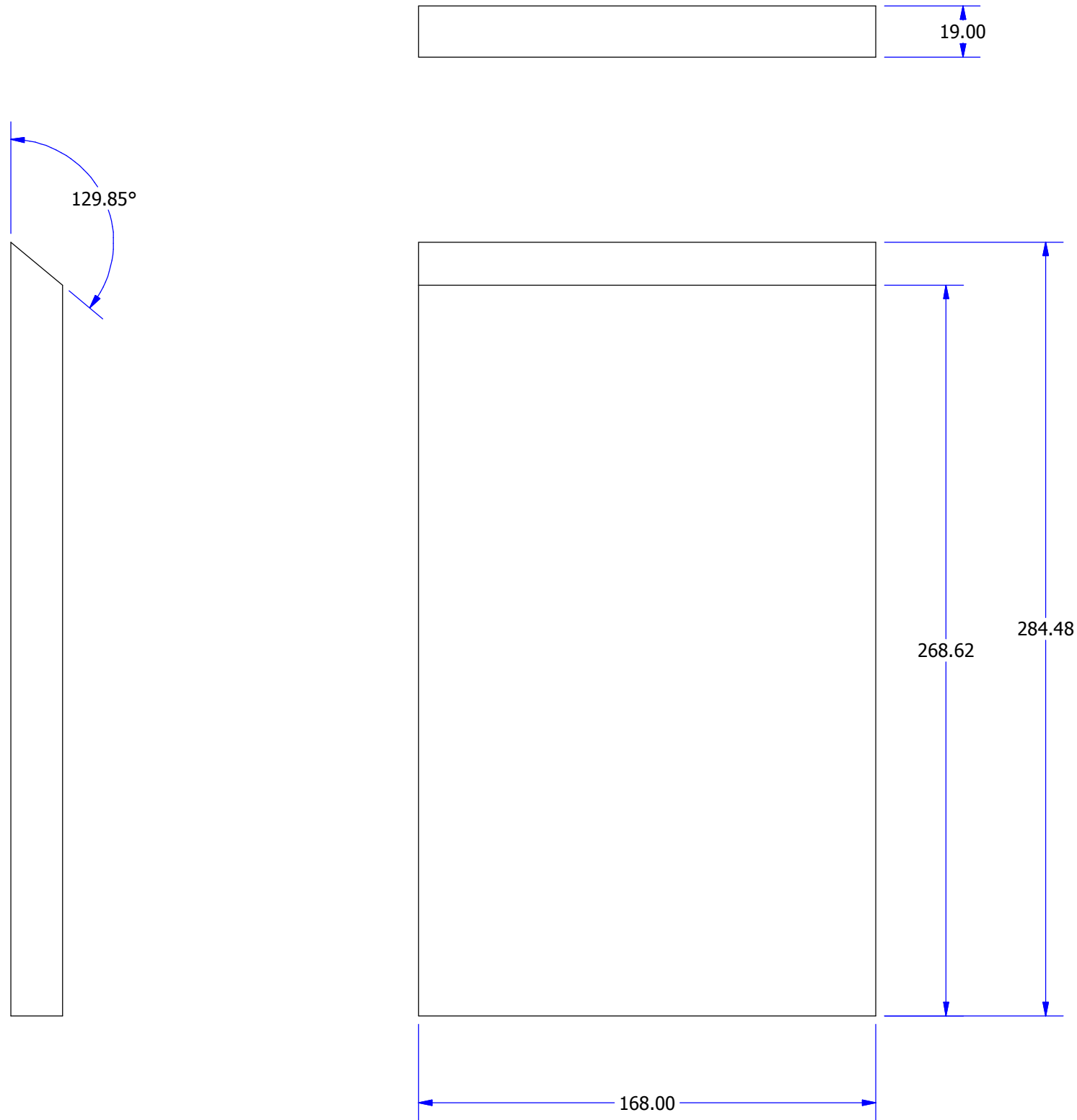

Panel 13

Andreas Mau

Knock Out

Andreas Mau			
Knock Out			
Sheet Number: 19 of 30	Date: 10/03/2015	Drawing Number: RQA3KO0001	Material: 19mm MDF
Sheet Size: A3	Drawn By: R. Quinton	Drawing Units: Millimeters	

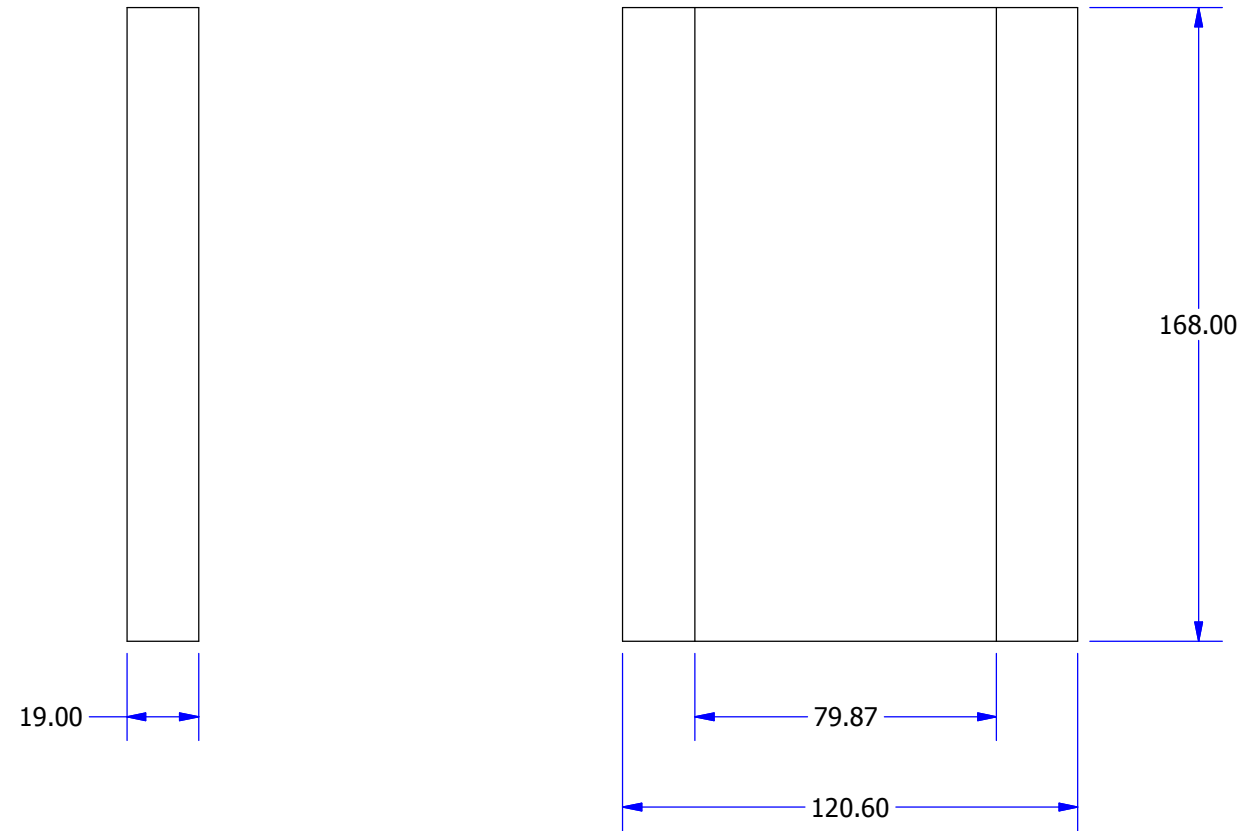
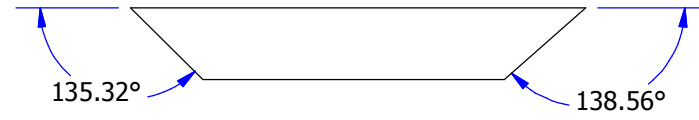

Panel 14

Andreas Mau

Knock Out

Andreas Mau			
Knock Out			
Sheet Number: 20 of 30	Date: 10/03/2015	Drawing Number: RQA3KO0001	Material: 19mm MDF
Sheet Size: A3	Drawn By: R. Quinton	Drawing Units: Millimeters	

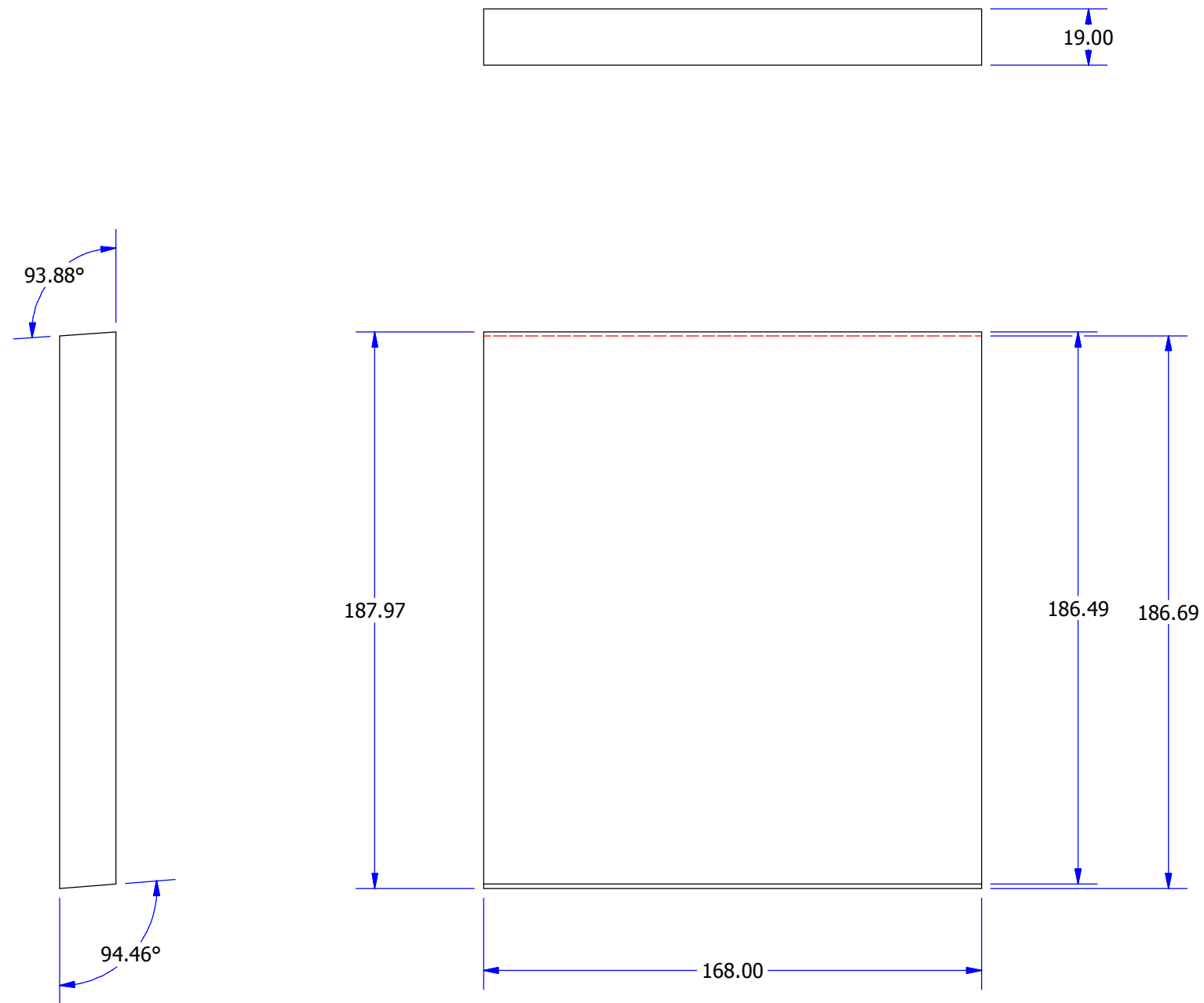

Panel 15

Andreas Mau

Knock Out

Andreas Mau			
Knock Out			
Sheet Number: 21 of 30	Date: 10/03/2015	Drawing Number: RQA3KO0001	Material: 19mm MDF
Sheet Size: A3	Drawn By: R. Quinton	Drawing Units: Millimeters	

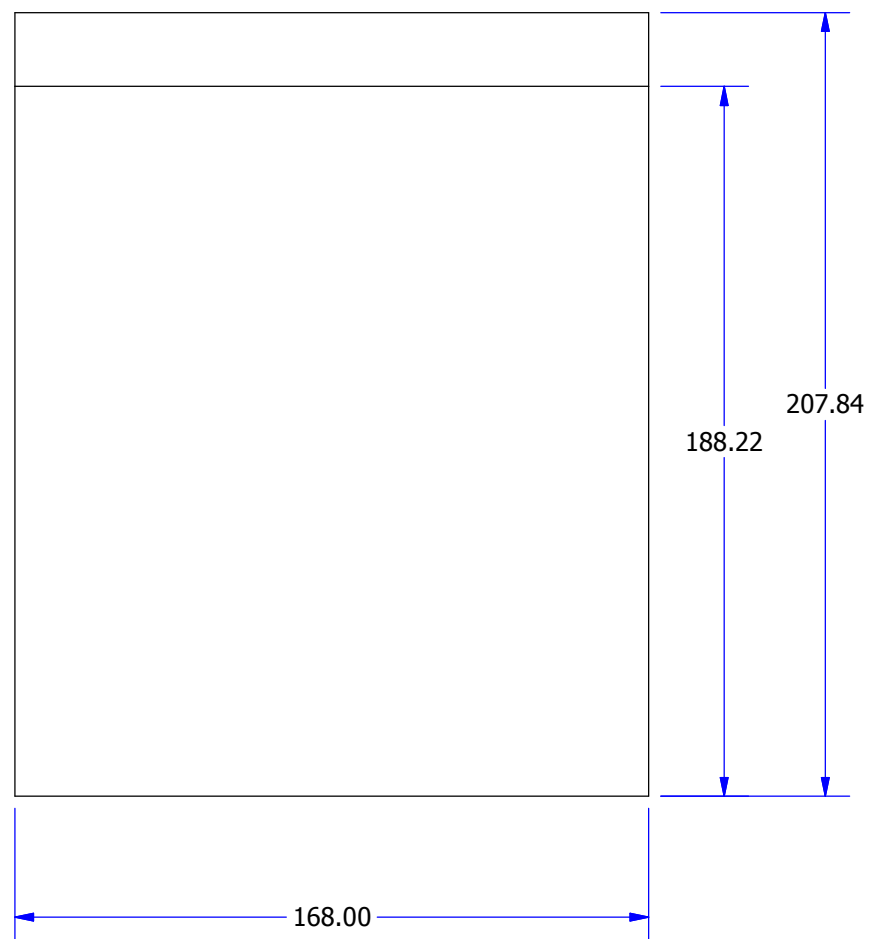
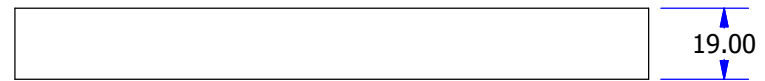

Panel 16

Andreas Mau

Knock Out

Andreas Mau			
Knock Out			
Sheet Number: 22 of 30	Date: 10/03/2015	Drawing Number: RQA3KO0001	Material: 19mm MDF
Sheet Size: A3	Drawn By: R. Quinton	Drawing Units: Millimeters	

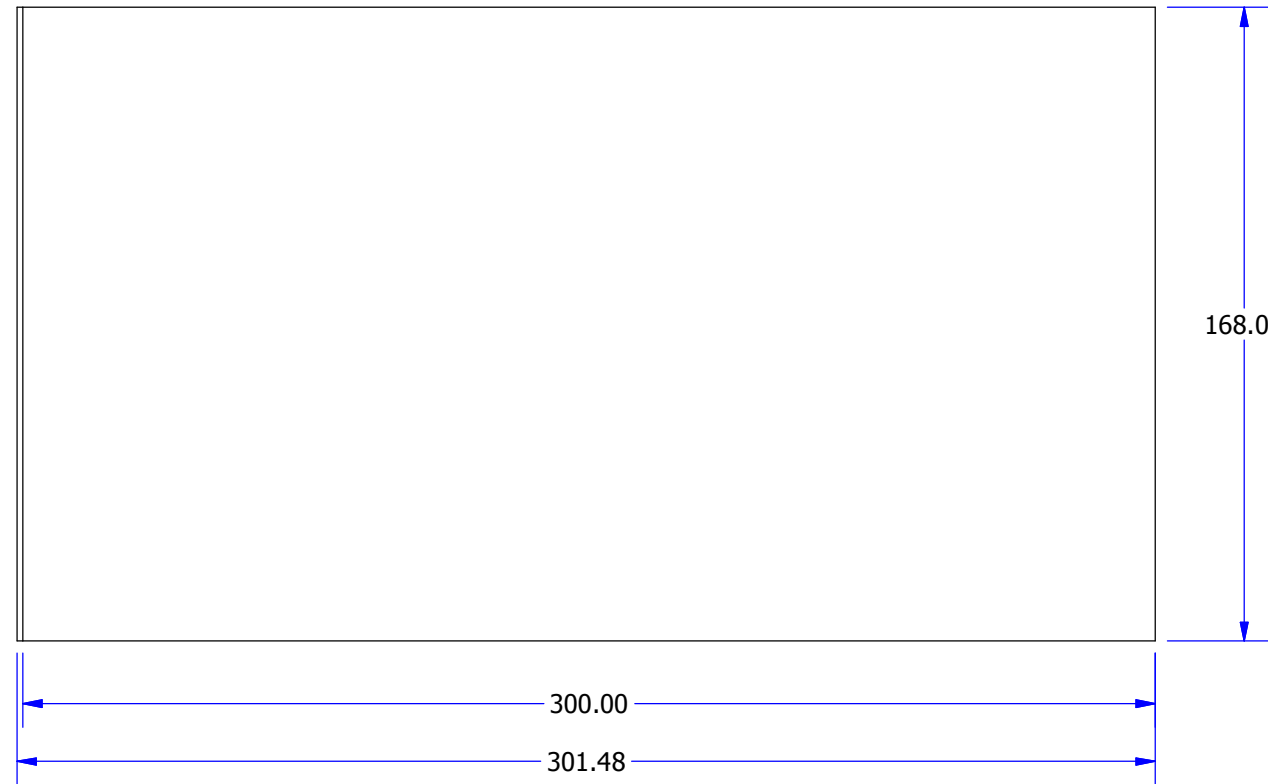
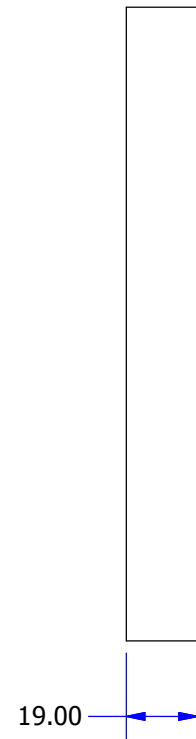
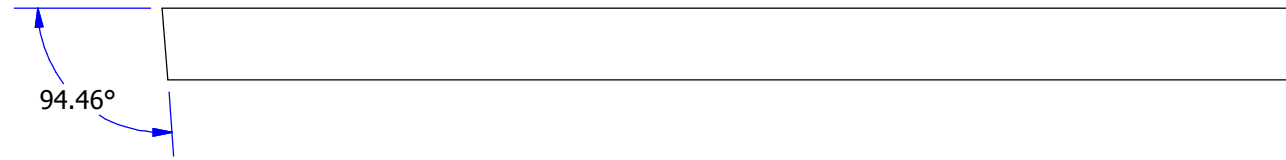

Panel 17

Andreas Mau

Knock Out

Andreas Mau			
Knock Out			
Sheet Number: 23 of 30	Date: 10/03/2015	Drawing Number: RQA3KO0001	Material: 19mm MDF
Sheet Size: A3	Drawn By: R. Quinton	Drawing Units: Millimeters	

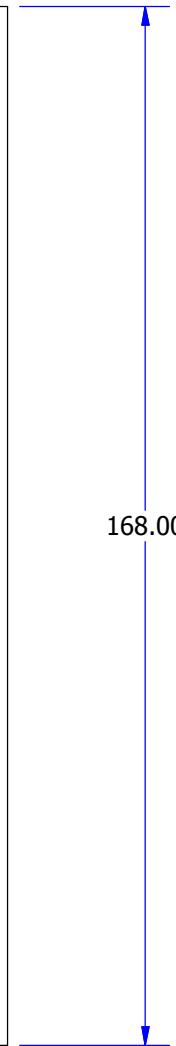
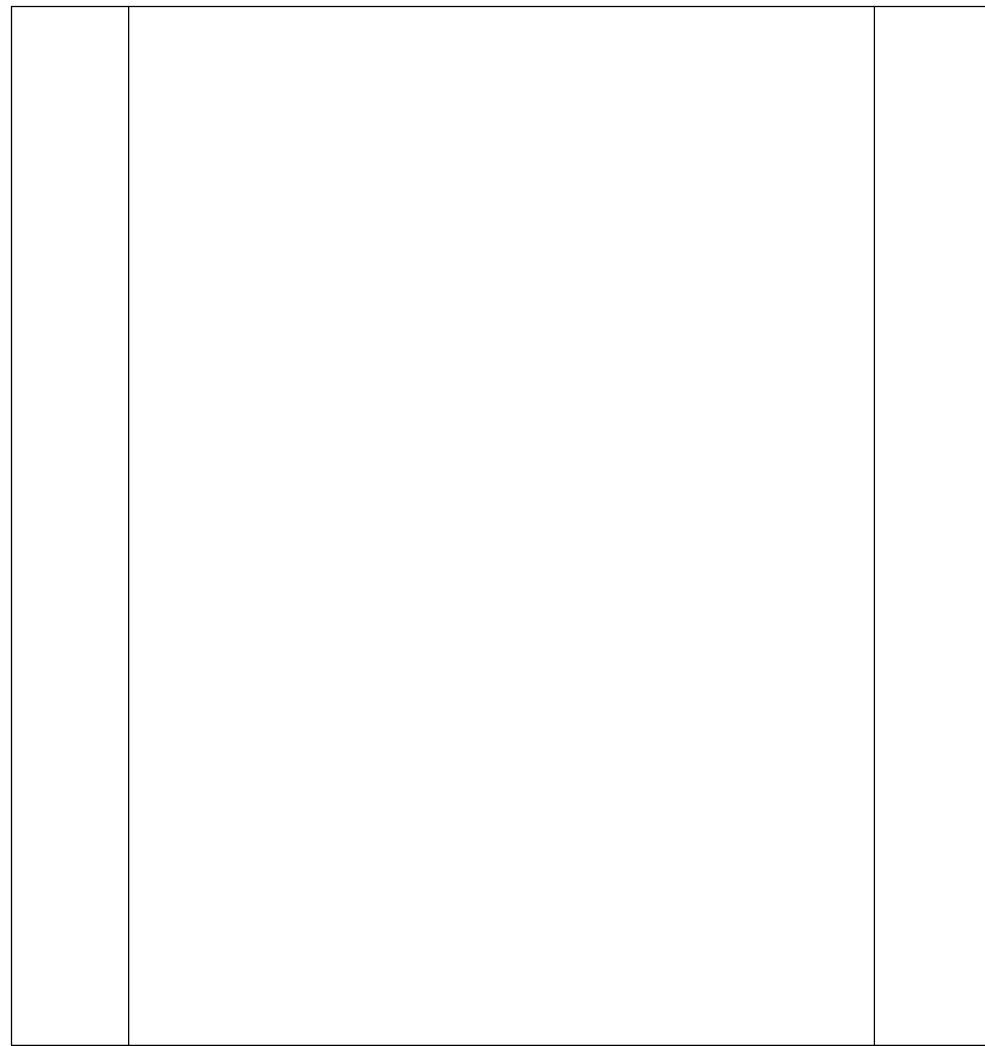
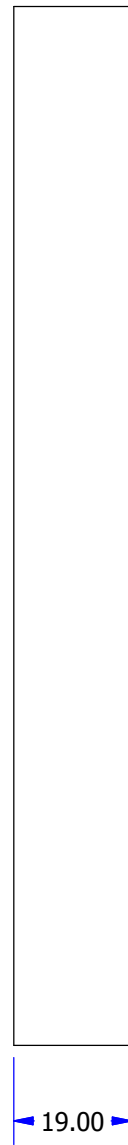

Panel 18

Andreas Mau

Knock Out

Andreas Mau			
Knock Out			
Sheet Number: 24 of 30	Date: 10/03/2015	Drawing Number: RQA3KO0001	Material: 19mm MDF
Sheet Size: A3	Drawn By: R. Quinton	Drawing Units: Millimeters	

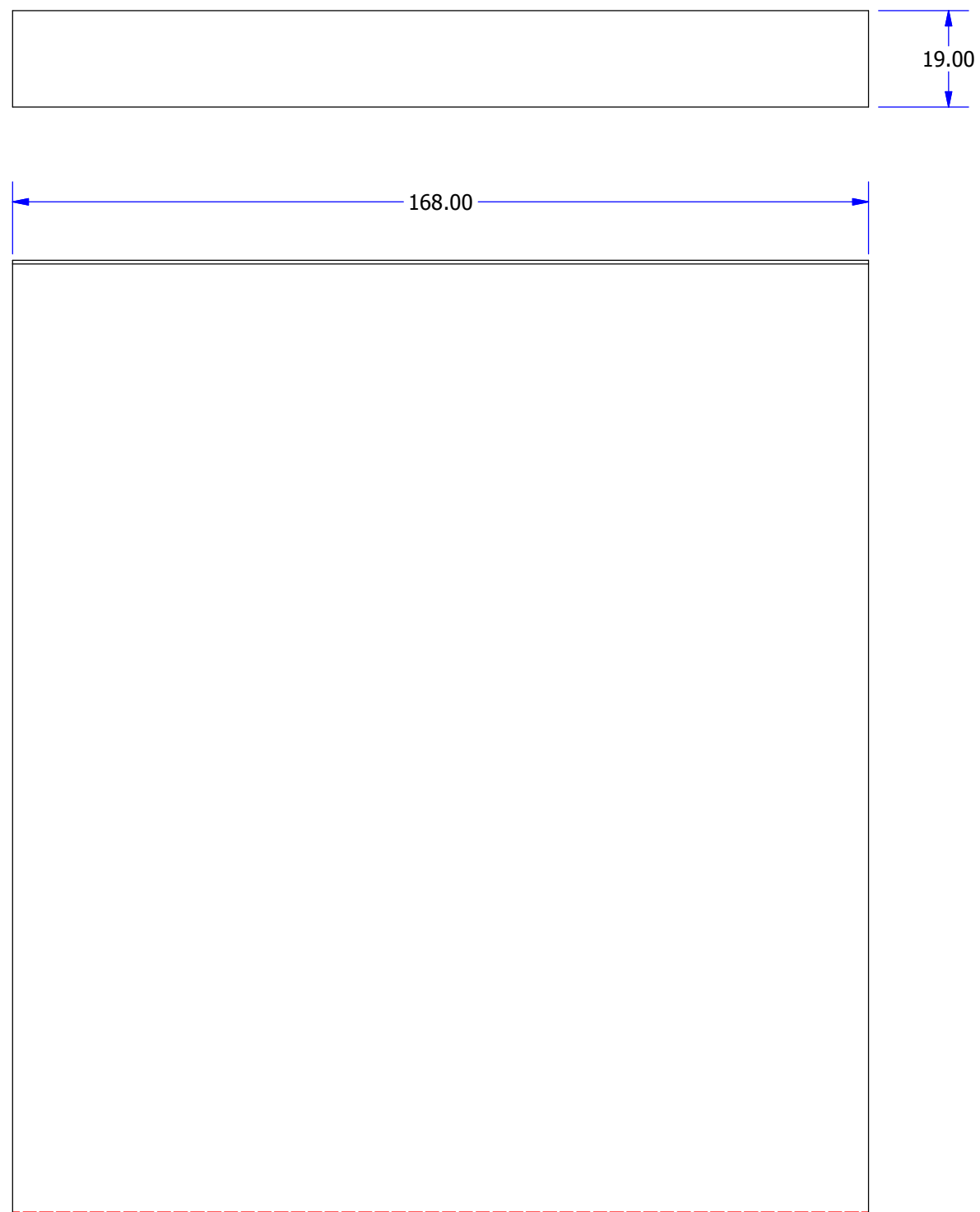
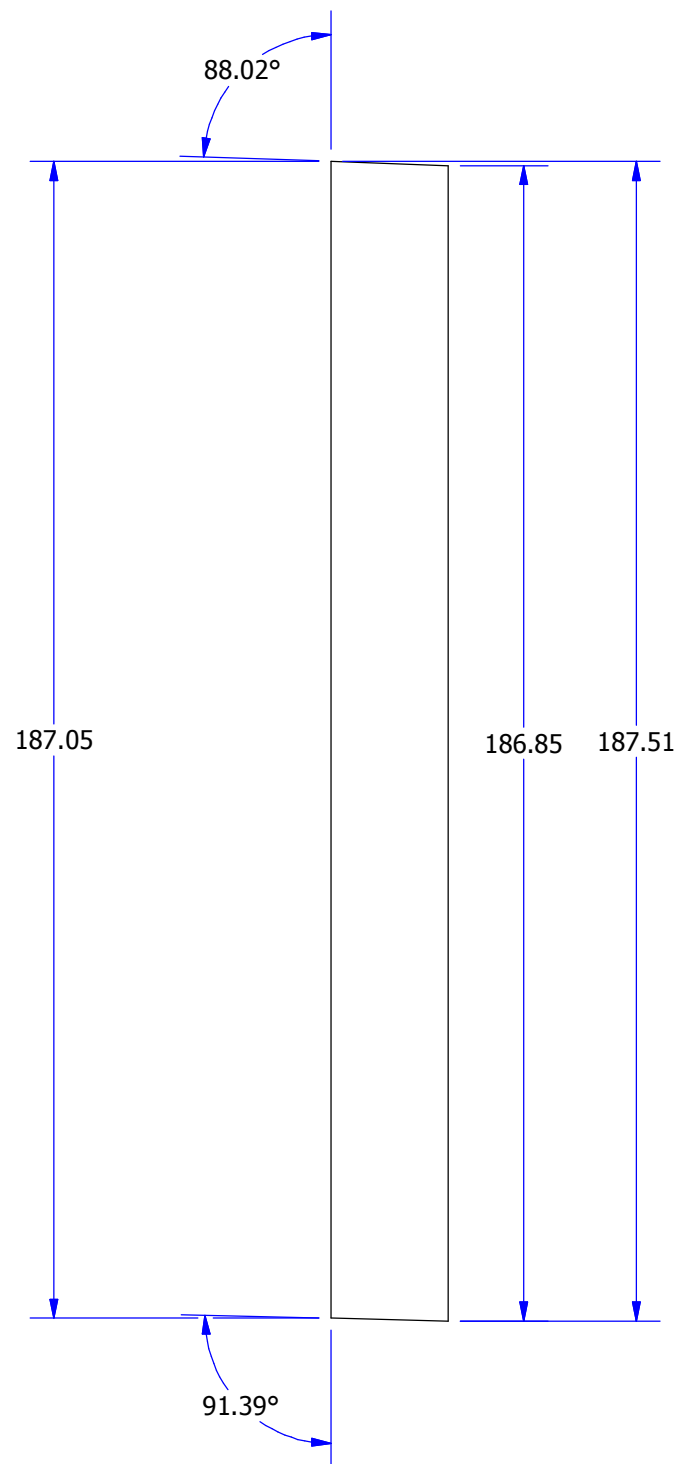

Panel 19

Andreas Mau

Knock Out

Andreas Mau			
Knock Out			
Sheet Number: 25 of 30	Date: 10/03/2015	Drawing Number: RQA3KO0001	Material: 19mm MDF
Sheet Size: A3	Drawn By: R. Quinton	Drawing Units: Millimeters	

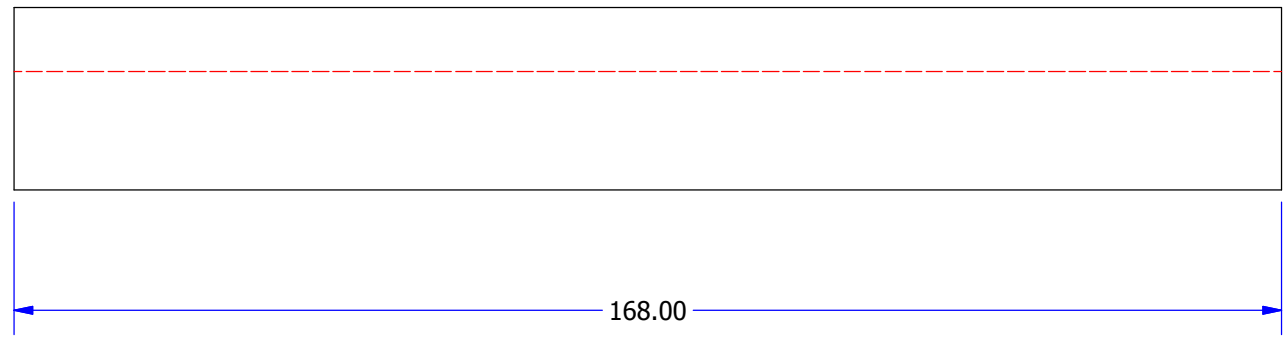
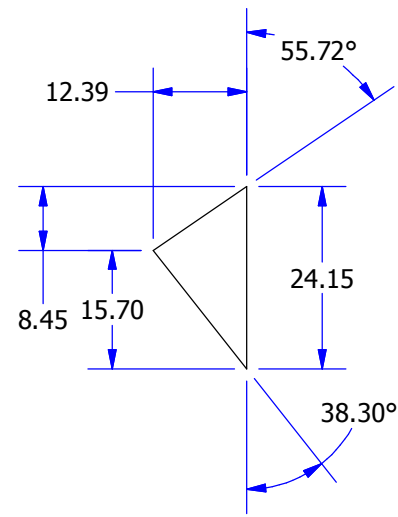

Corner Block 1

Andreas Mau

Knock Out

Andreas Mau			
Knock Out			
Sheet Number: 26 of 30	Date: 10/03/2015	Drawing Number: RQA3KO0001	Material: Suitable Battening
Sheet Size: A3	Drawn By: R. Quinton	Drawing Units: Millimeters	

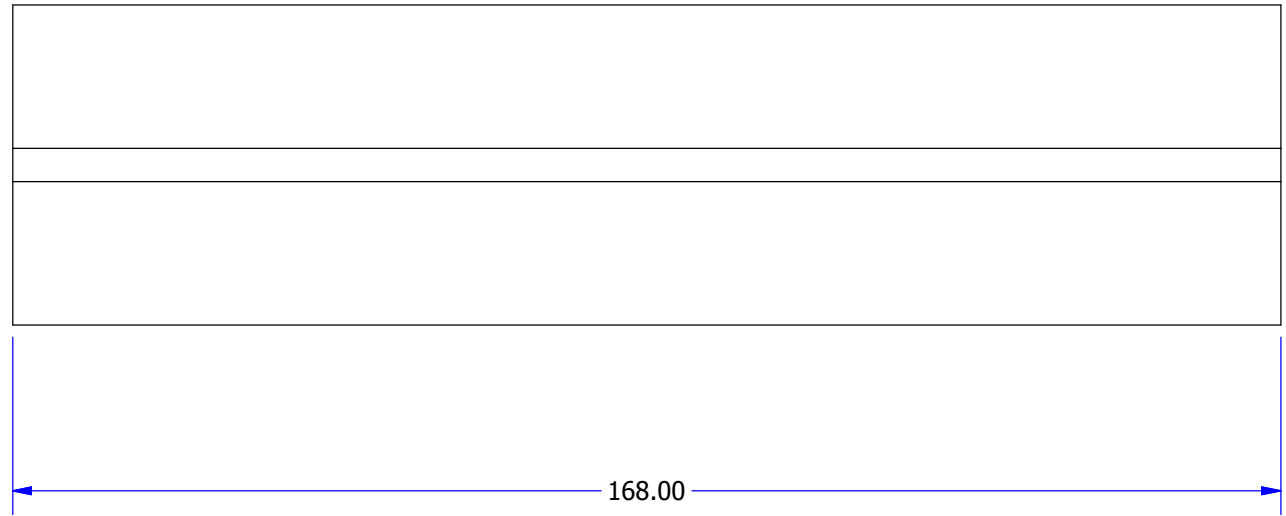
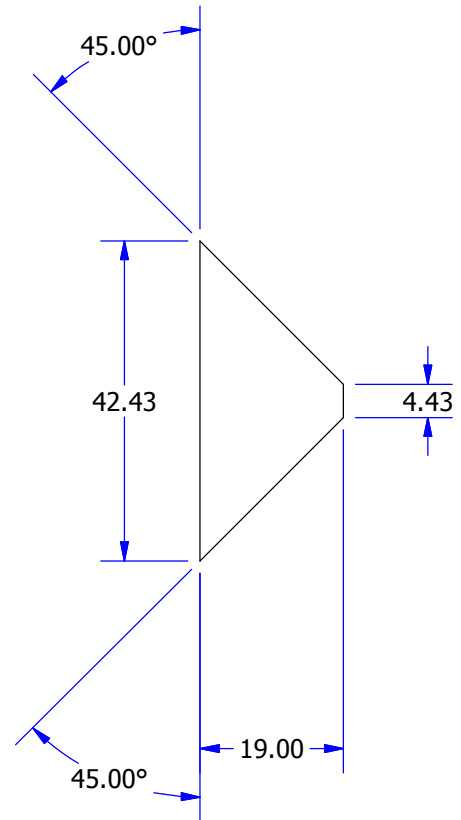

Corner Block 2

Andreas Mau			
Knock Out			
Sheet Number: 27 of 30	Date: 10/03/2015	Drawing Number: RQA3KO0001	Material: Suitable Battening
Sheet Size: A3	Drawn By: R. Quinton	Drawing Units: Millimeters	

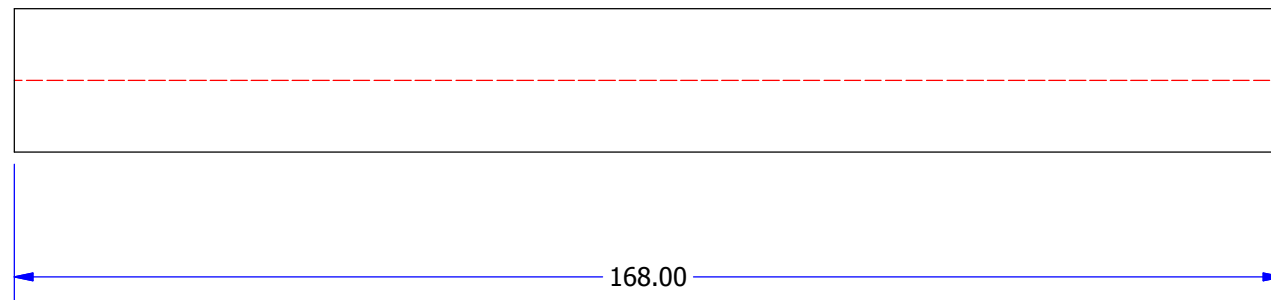
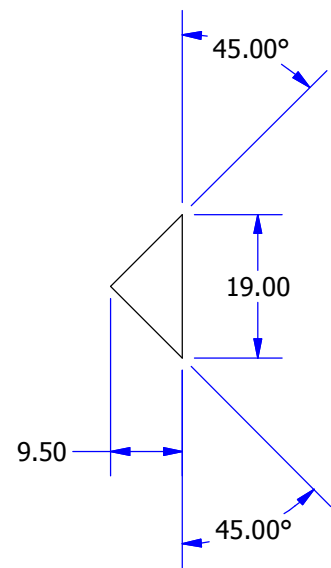

Corner Block 3

Andreas Mau

Knock Out

Andreas Mau			
Knock Out			
Sheet Number: 28 of 30	Date: 10/03/2015	Drawing Number: RQA3KO0001	Material: Suitable Battening
Sheet Size: A3	Drawn By: R. Quinton	Drawing Units: Millimeters	

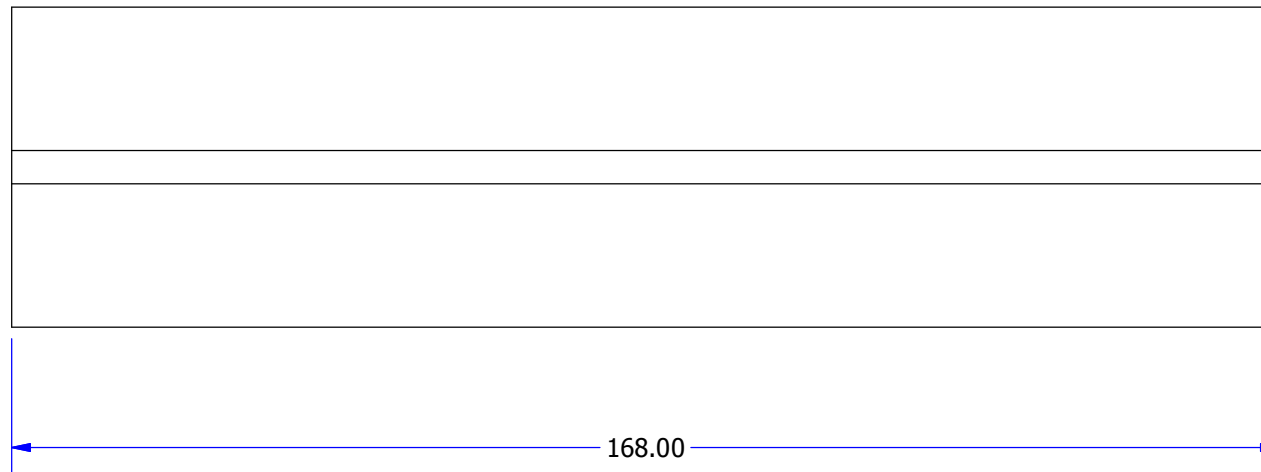
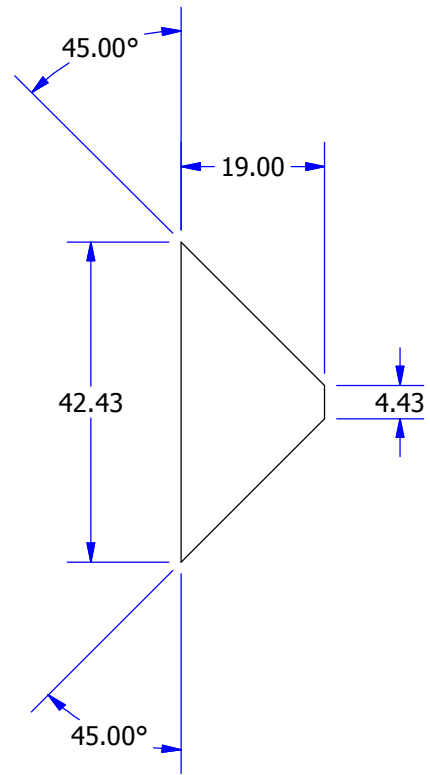

Corner Block 4

Andreas Mau

Knock Out

Andreas Mau			
Knock Out			
Sheet Number: 29 of 30	Date: 10/03/2015	Drawing Number: RQA3KO0001	Material: Suitable Battening
Sheet Size: A3	Drawn By: R. Quinton	Drawing Units: Millimeters	

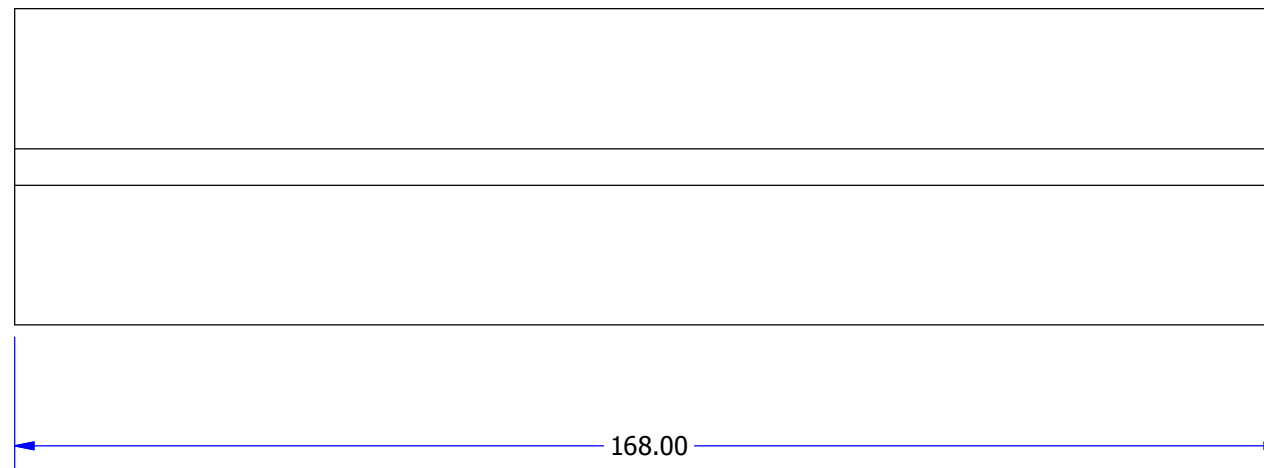
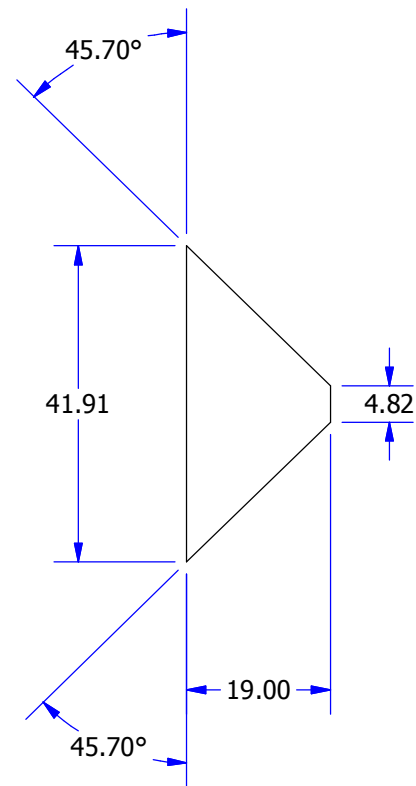

Corner Block 5

Andreas Mau

Knock Out

Andreas Mau			
Knock Out			
Sheet Number: 30 of 30	Date: 10/03/2015	Drawing Number: RQA3KO0001	Material: Suitable Battening
Sheet Size: A3	Drawn By: R. Quinton	Drawing Units: Millimeters	