

MAUHORN Signature One

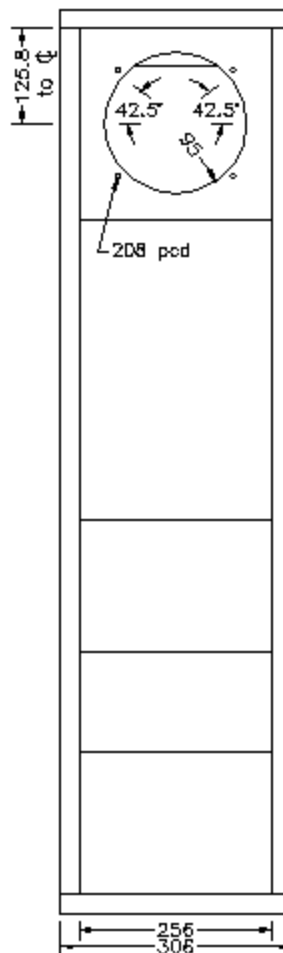
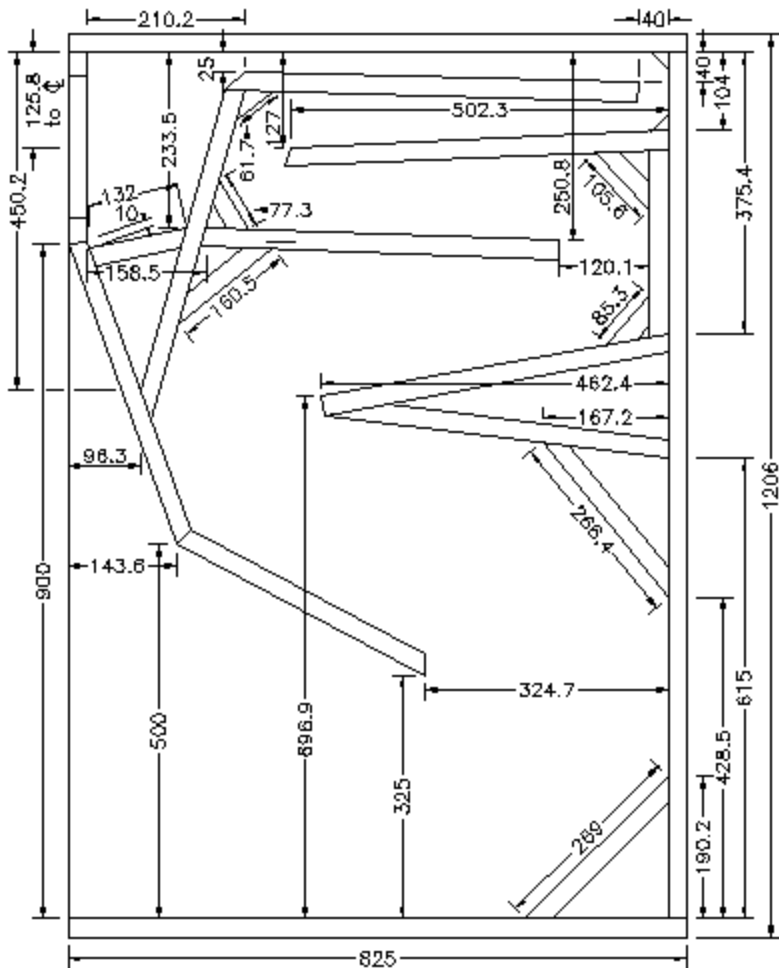

Material: 25mm MDF or Marine Ply.

Designed to accept Lowther Loudspeaker drivers, models 2, 3 and 4.

© Design by Andreas Mauw

MAUHORN Signature One

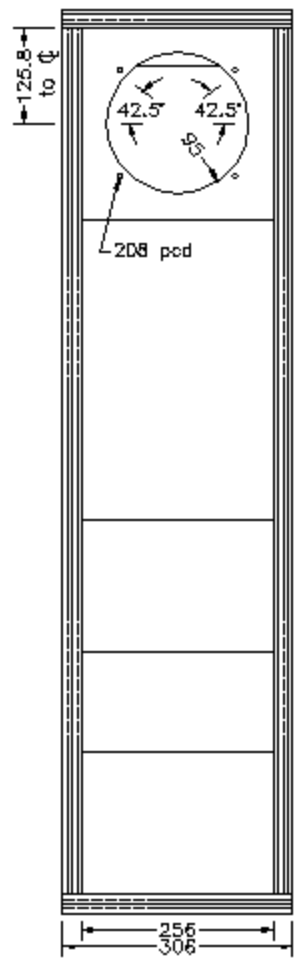
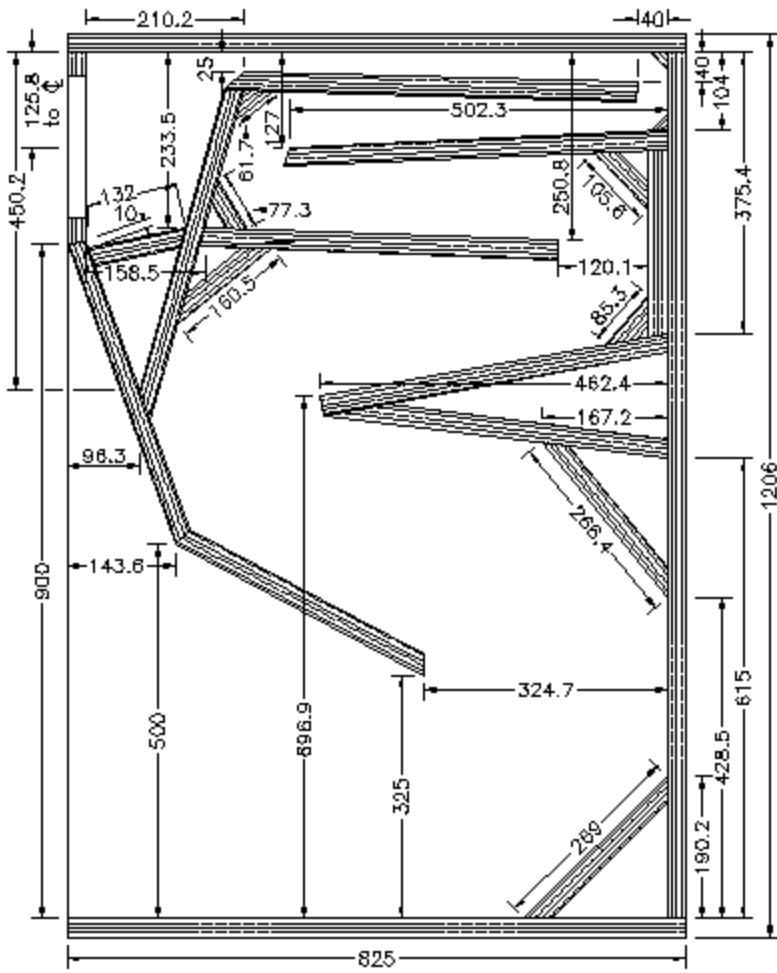

Material: 25mm MDF or Marine Ply.

Designed to accept Lowther Loudspeaker drivers, models 2, 3 and 4.

© Design by Andreas Mauw

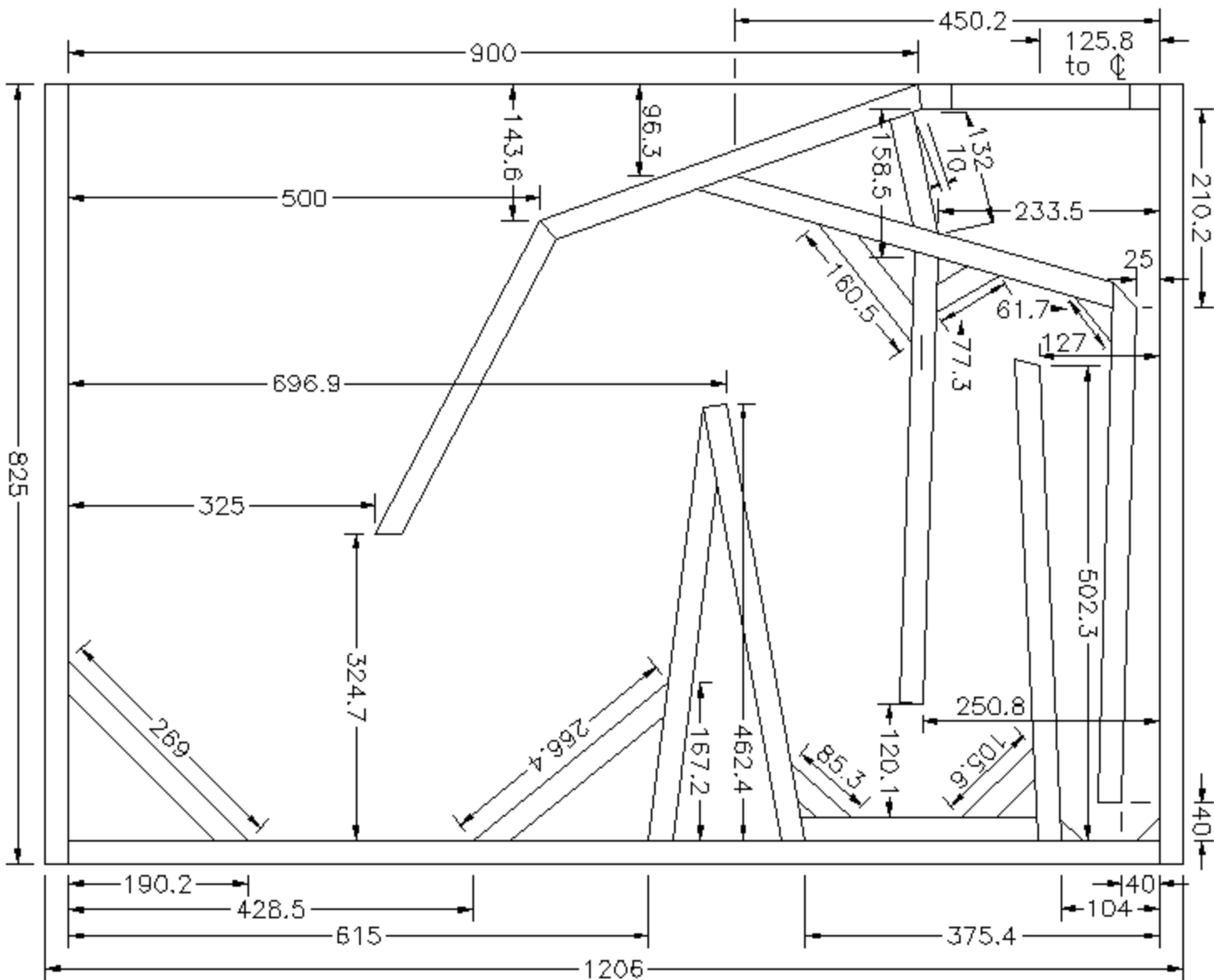

MAUHORN Signature One

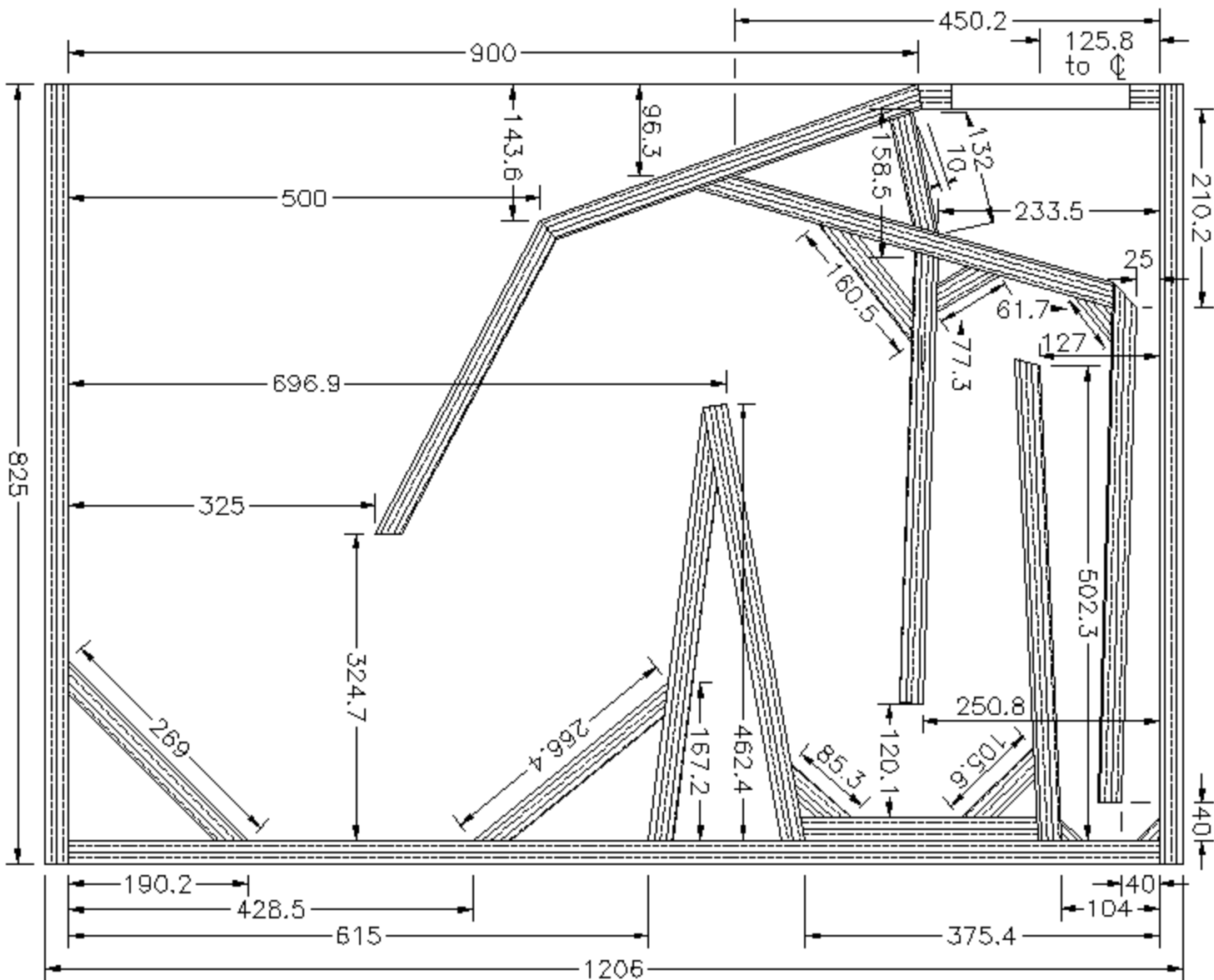

MAUHORN Signature One

MAUHORN Signature One

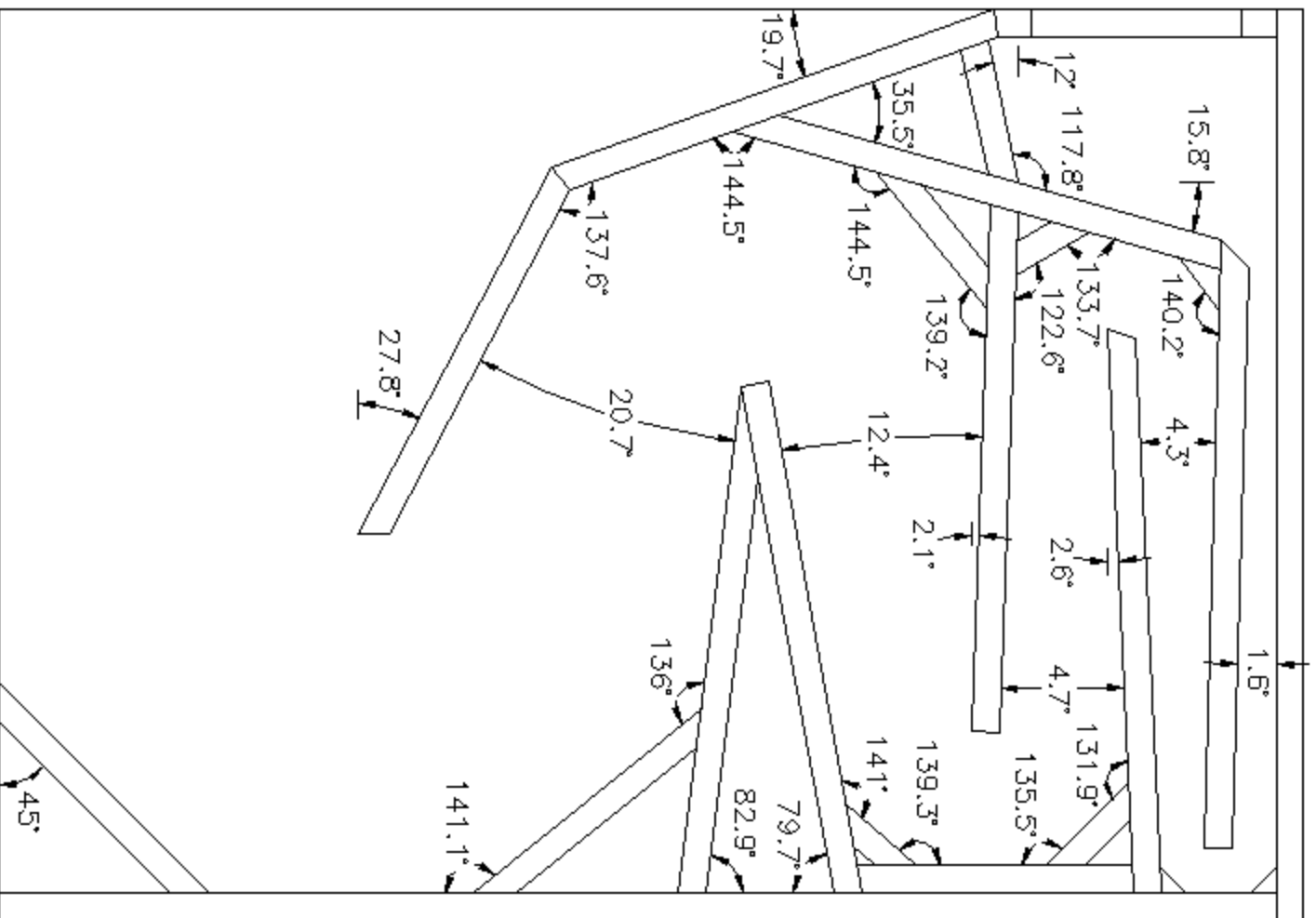

MAUHORN Signature One

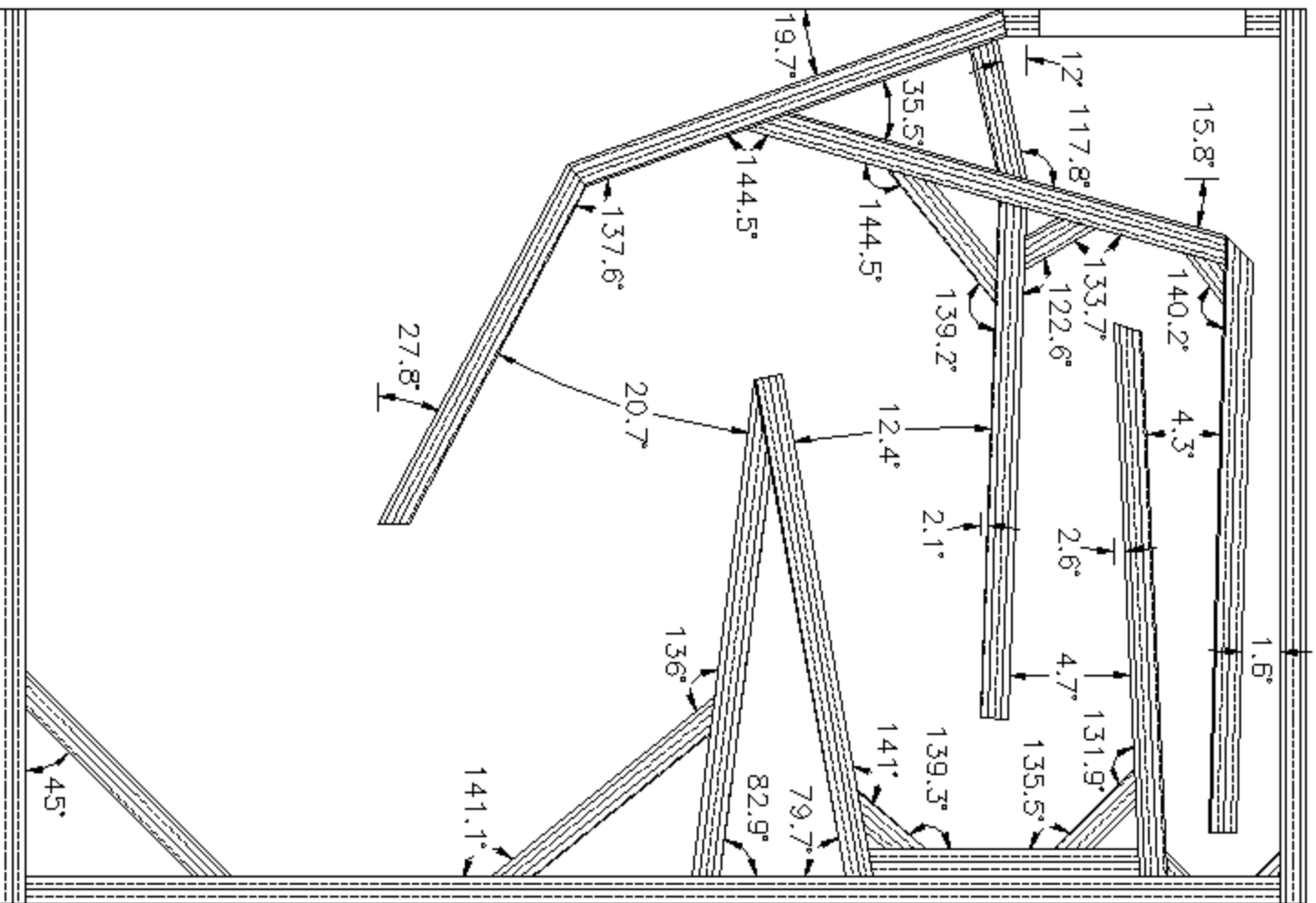

MAUHORN Signature One

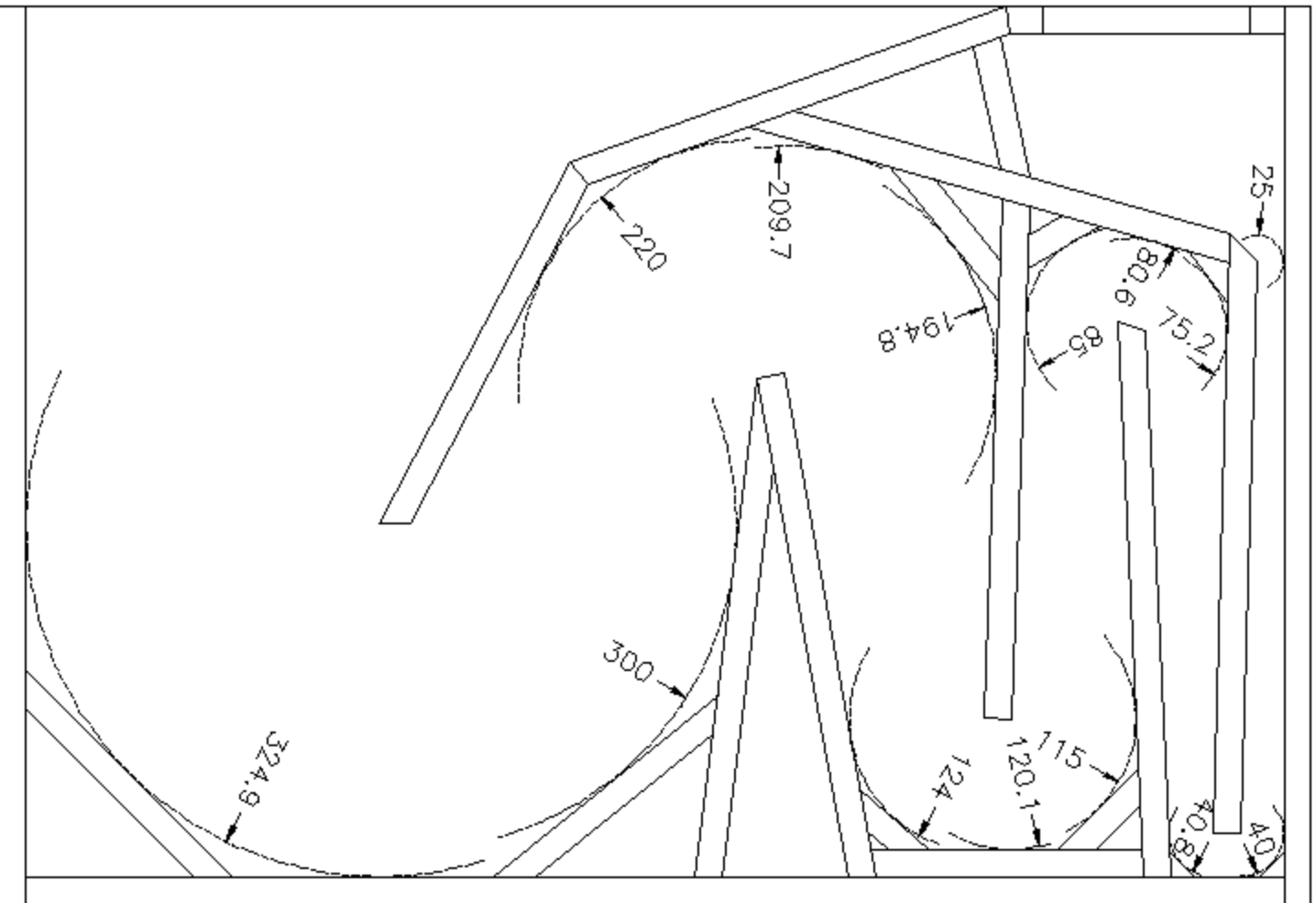

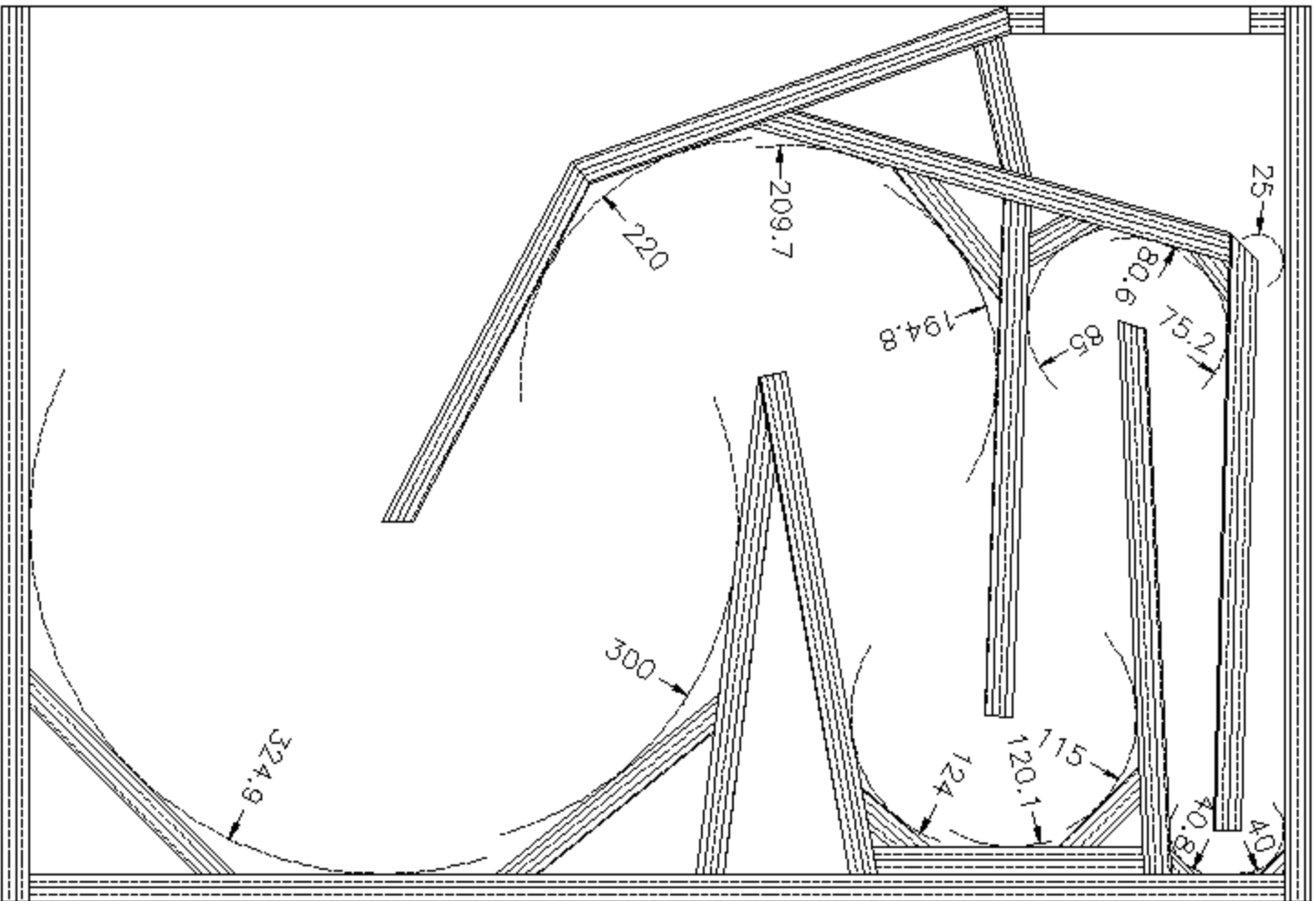

MAUHORN Signature One



MAUHORN Signature One

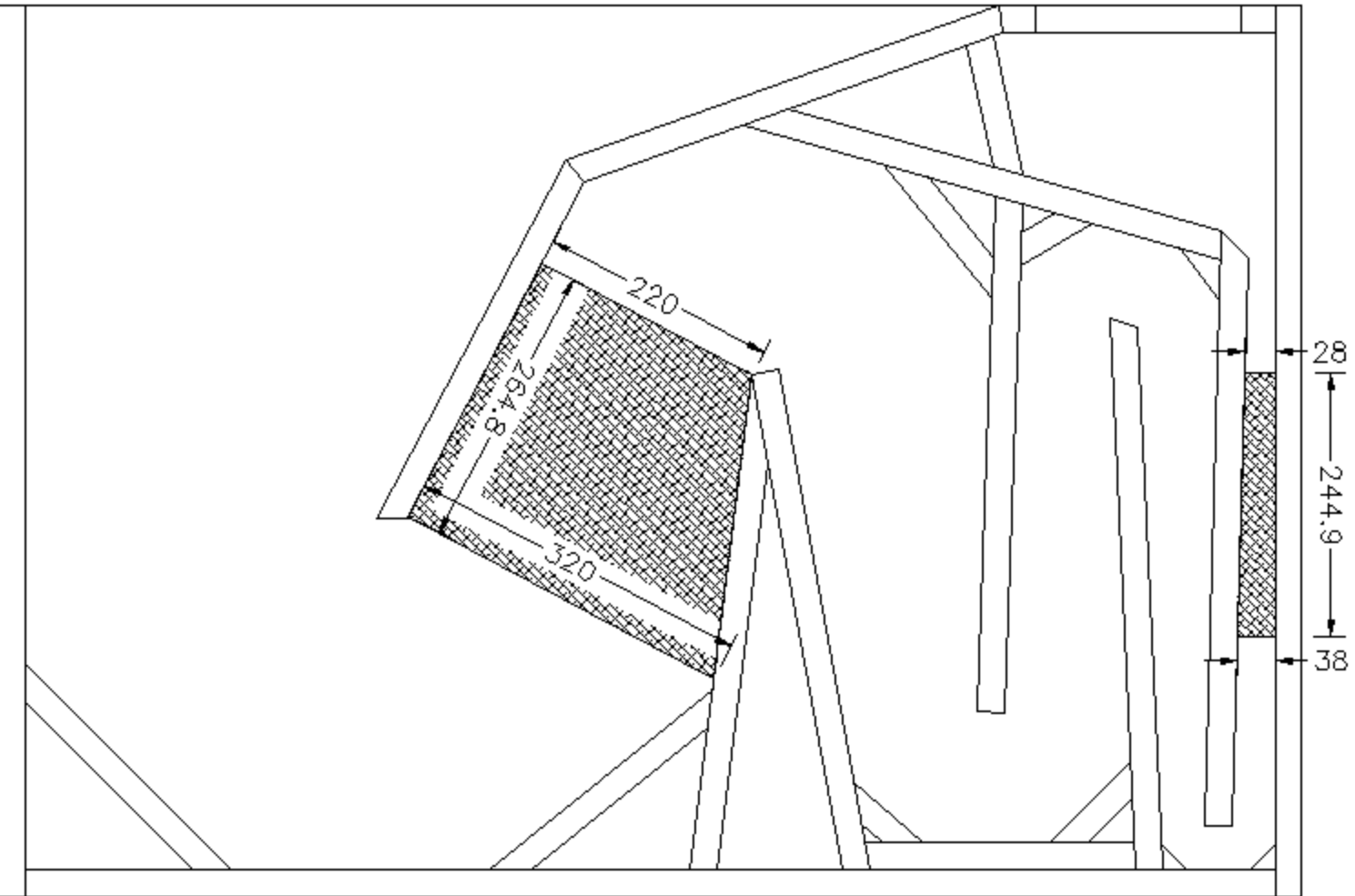

MAUHORN Signature One

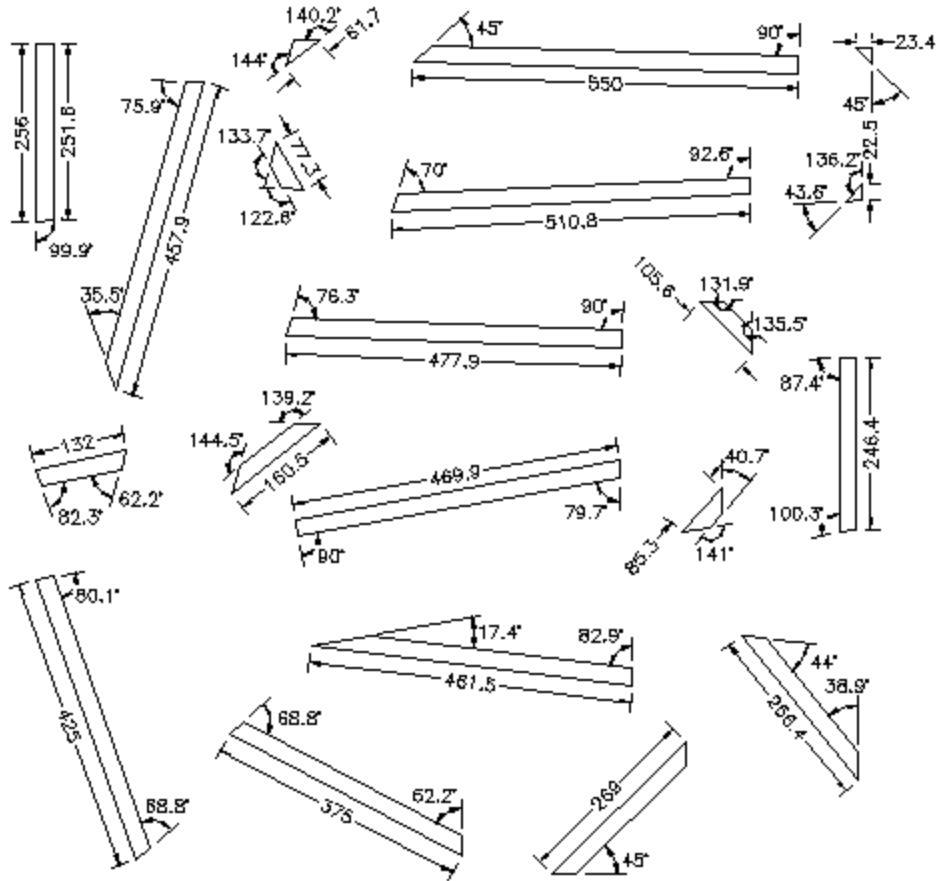
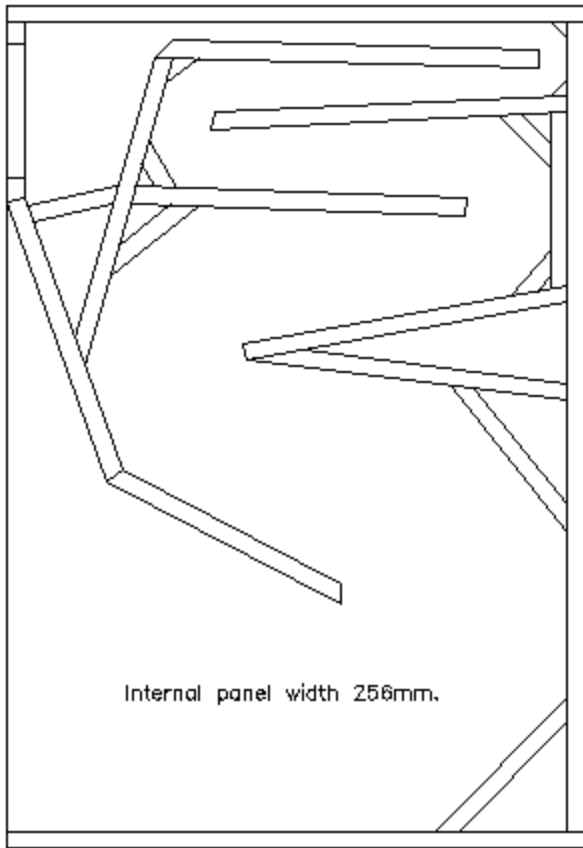

MAUHORN Signature One

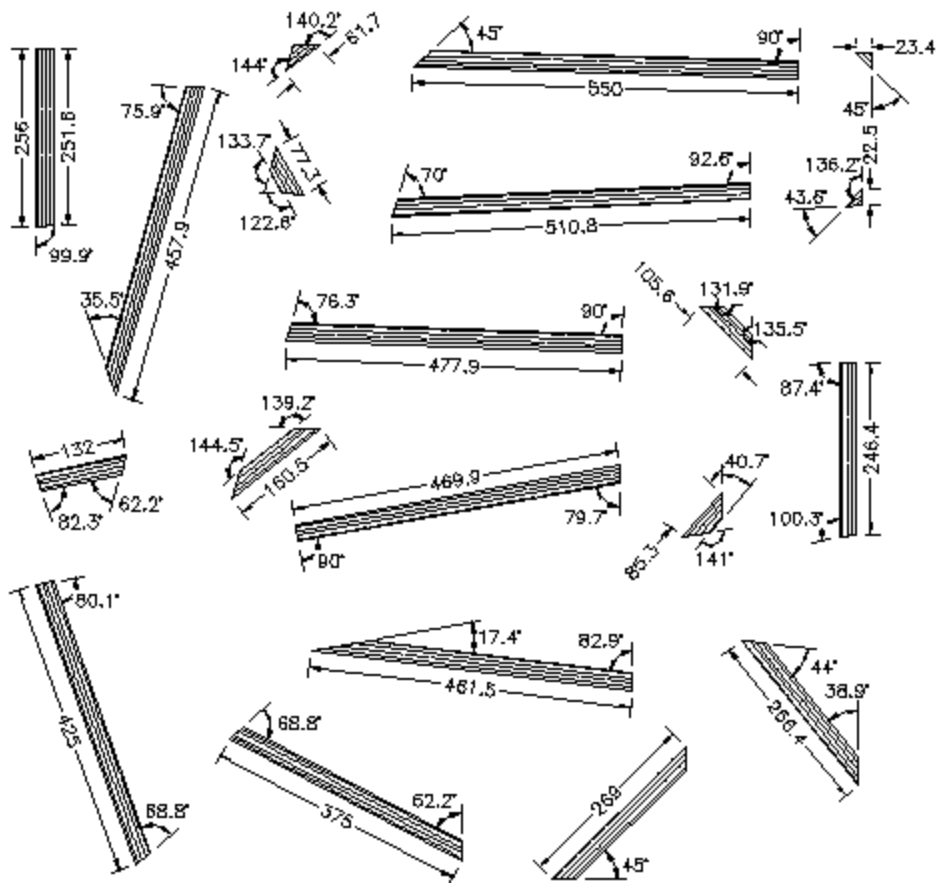
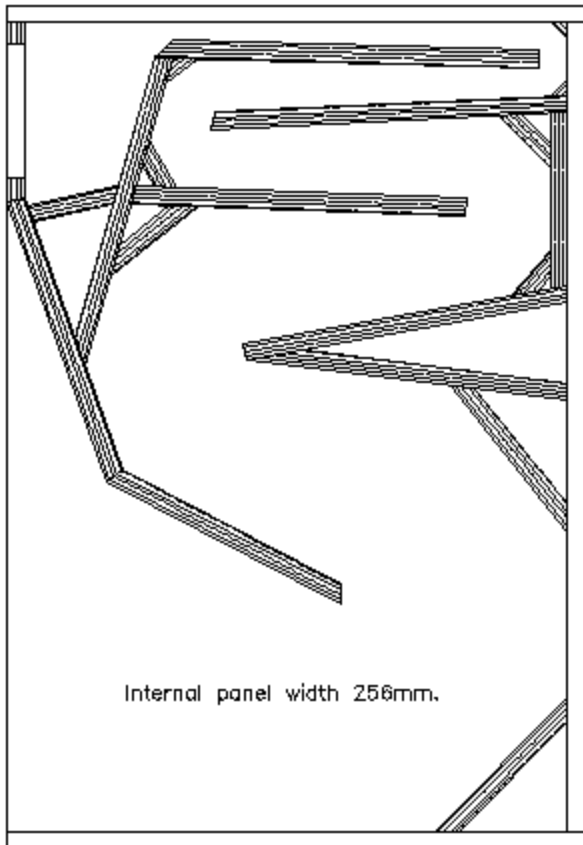

MAUHORN Signature One

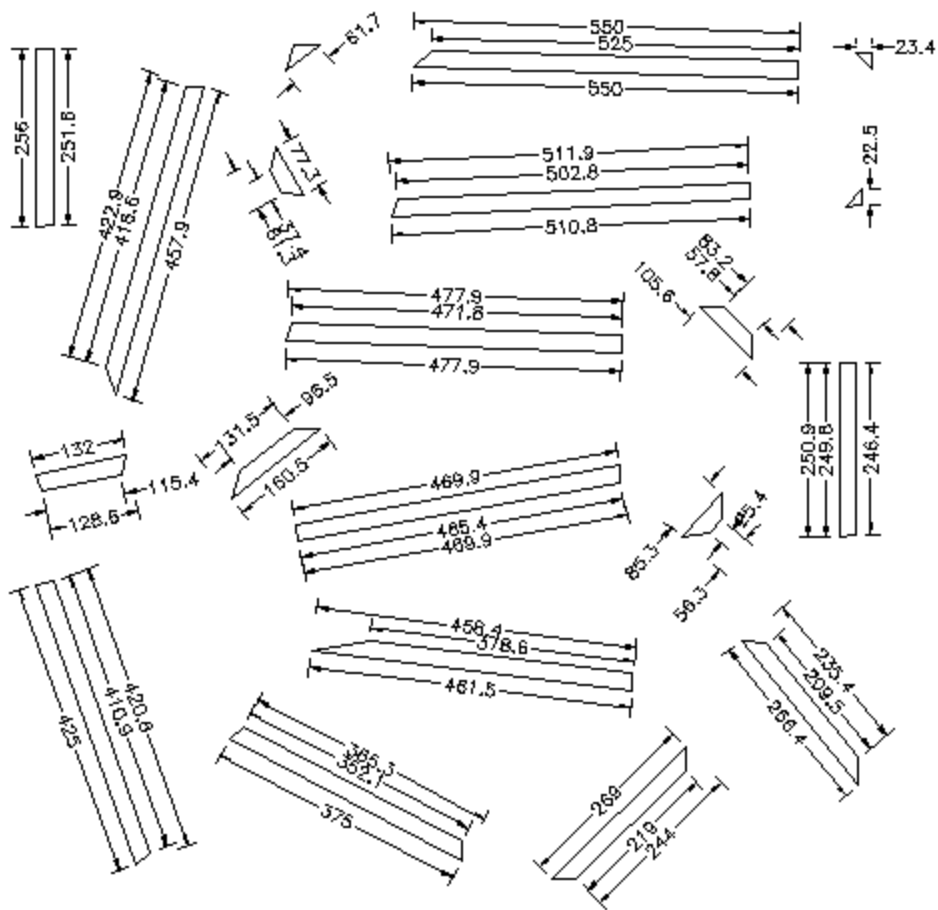
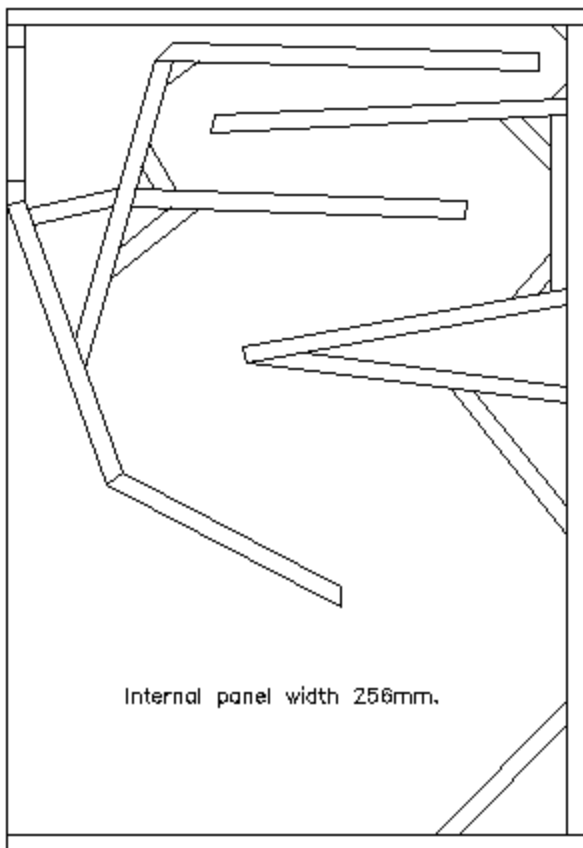

MAUHORN Signature One

